

**CAUSES OF ROOF FAILURE AND MODELLING OF PITCHED
ROOF BLOW -OFF IN SOUTHWESTERN NIGERIA**

BY

SUNDAY OLUFEMI ADESOGAN

(MATRIC NO: 84408)

B.Sc. Civil Engineering (Ife), M.Sc. Agricultural Engineering (Ibadan)

MNSE,

COREN-REGISTERED ENGINEER

**A THESIS SUBMITTED TO AGRICULTURAL AND ENVIRONMENTAL
ENGINEERING DEPARTMENT, FACULTY OF TECHNOLOGY
UNIVERSITY OF IBADAN, IBADAN, NIGERIA**

**IN PARTIAL FULFILMENT OF THE REQUIREMENTS FOR THE AWARD OF THE
DEGREE OF DOCTOR OF
PHILOSOPHY OF THE UNIVERSITY OF IBADAN**

AUGUST 2011

CERTIFICATION

This is to certify that this project work was carried out by Sunday Olufemi Adesogan with student Matriculation Number **84408** in the Department of Agricultural and Environmental Engineering, Faculty of Technology, University of Ibadan, Nigeria under my direct supervision.

Supervisor

Yahaya Mijinyawa

B.Sc., M.Sc., Ph.D (Ibadan)

FNIAE, MNSE, R. Engr. (COREN)

Reader,

Department of Agricultural and Environmental Engineering

Faculty of Technology

University of Ibadan

Nigeria

DEDICATION

This research work is dedicated to the Almighty God, the giver of life and the dispenser of knowledge for His loving kindness, tender mercies, daily blessing, protection and journey mercies since the commencement of this programme in the University of Ibadan.

UNIVERSITY OF IBADAN

ACKNOWLEDGEMENT

My profound gratitude goes to my Supervisor, Dr. Yahaya Mijinyawa that has taken this research work as his baby. I appreciate him for his guidance, sacrifice, suggestions, understanding, technical advice, valuable contribution, mentoring and patience in reading and correcting my write up despite his tight schedule at all various stages of the work. The door to his house was opened twenty-four hours daily for my consultation. I have been gladly adopted as a member of his family. His brotherly guidance and support at every stage were vital to the success of this research work.

I acknowledge Rev'd Canon Professor E. Babajide Lucas, the indefatigable and Co-Supervisor who took up the challenges of nursing this project when the substantive supervisor was out of the country, he had made himself a ready help in time of need, Without him, this research will not be conclusive. He is always there for me. He is a father, priest, counsellor and mentor. I wish to express my profound appreciation to him for all he has been to me. Thank you sir, May the Almighty God grants you all your heart desires.

I shall be the most ungrateful if the fatherly support of Prof J.C. Igbeka is not appreciated. He was just prompt at mediating at the point of confusion. I am greatly indebted to the Acting Head of Department, Dr. A.I Bamgboye who is eager to see me complete the research. My appreciation also goes to all the postgraduate lecturers in the Department, Prof. Yisa Sangodoyin, Prof. M.A. Onilude, Prof. A.O. Olorunnisola, Prof. E.A Ajav, Dr. Kola Ogedengbe, Dr. A.O.Raji, and Dr. A.K. Aremu. They were all interested in the research work. After the normal greetings, I can always guess the next statement from them "Bo ni ise de duro bayii?" I find this atmosphere of love very enabling.

Thanks to many more who have in their ways contributed to the success of this research work. I am greatly indebted to my dear wife, Deborah Ogunpeju Adesogan who was always taking care of our natural products while I was not around; my deep appreciation to my daughters; Mesasinnu Olurokan Adesogan, Mejasolite Olulanaayo Adesogan and Mesesingbe Oluwaromilasoiki Adesogan. Also, I appreciate the supportive role of Mrs Toyin Adebayo (nee Ogunyale), my wonderful sister. Their collective patience, endurance, encouragement, moral and financial support saw me through. To them I am highly grateful.

My appreciation goes to my dear daughter, Christiana Olufunke Akindasa who did the typing of the manuscript, sometimes staying lonely in the office till night. I wish to also put on record the efforts of my brothers, Pharmacist Oludare Ipadeola and Engr. Oluwadare Joshua Oyebode that were my own Barnabas throughout the research. The impact of Oyebode in the graphics features, diagrams, AUTOCAD

drawings, proof reading, and browsing, editing and moral supports is highly appreciated. Many thanks also to Dr. A.C. Odebode for his pep talks. Great appreciation goes to Pa Yinka Ogundipe for providing me with data for the research. The moral support, prayer and encouragement of the whole members of Ayanniyi family are highly appreciated. Tolu Ayanniyi, 'Bayo Ayanniyi, 'Kemi Ayanniyi, 'Lara Ayanniyi, Mrs B.O. Ayangbile and Mr. A. Ayangbile, thank you all. My appreciation goes to "a boy" Dr. A.E. Awoyemi the initiator of the research work who will never see anything good in standing still where I was.

Last but not the least; copious individuals have been responsible for the accomplishment of this research that no one list can adequately include them all. May God bless you and make all your dreams a reality.

UNIVERSITY OF IBADAN

TABLE OF CONTENTS

TITLE PAGE	i
CERTIFICATION	ii
DEDICATION	iii
ACKNOWLEDGEMENT	iv
TABLE OF CONTENTS	vi
LIST OF FIGURES	xi
LIST OF PLATES	xiii
LIST OF TABLES	xiv
LIST OF APPENDICES	xv
ABSTRACT	xvi
CHAPTER ONE: INTRODUCTION	1
1.1 General Background	1
1.2 Objectives	2
1.3 Justification	2
1.4 Scope of the Study	3
CHAPTER TWO: LITERATURE REVIEW	4
2.1 General	4
2.2 Components of a Roof	5
2.3 Historical Development of Roofing Materials	7
2.4 Roofing Materials	9
2.4.1 Materials for Truss	9
2.4.2 Materials for Roof Covering	13
2.5 Functions and Functional Requirements of Roof	19
2.5.1 Functions of Roofs	19
2.5.2 Functional Requirements of Roof	20
2.5.3 Economic Importance of Roof	22
2.6 Types Of Roofs	24
2.6.1 Classification According to Pitch of the Roof	24
2.6.2 Classification According to Shape	26

2.7	Choice of Roof Type	33
2.7.1	Size and Shape of Building	33
2.7.2	Aesthetics	33
2.7.3	Cost	34
2.7.4	Climatic Factors	34
2.7.5	Type of Trusses	34
2.8	Roof Failures	35
2.8.1	Ultimate Failure	35
2.8.2	Serviceability Failure	35
2.8.3	Special Requirement Failure	35
2.9	Modelling	36
2.9.1	Definition	36
2.9.2	Classification of Models	36
2.9.3	Steps in using Models to Solve Decision Problem	38
CHAPTER THREE : MATERIALS AND METHODS		40
3.1	Preamble	40
3.2	Survey	40
3.2.1	Study Location	40
3.2.2	Survey Instruments	41
3.2.3	Sample Size	42
3.2.4	Field Work	42
3.3	Experiments	43
3.3.1	Determination of Moisture Content	43
3.3.2	Corrosion Test on Nails	43
3.3.3	Determination of the Effects of Temperature Fluctuations	44
3.3.4	Effects of interface gap on Joint Integrity	44
3.4	Development of Roof Blown-off Model	45
3.4.1	Algorithm for the Blow-off Model	46
3.5	Model Validation	48
3.6	Development of the Model	48

3.6.1	Building Topographical Location	48
3.6.2	Roof geometry	52
3.6.3	Roof orientation	55
3.6.4	Comparison of areas of roof under attack	57
3.6.5	Calculation of the hip length of hip roof	59
3.7	Optimization of Pitch Angle	60
3.8	Courtyard Effect on Wind Flow	62
3.9	Determination of maximum Design Wind speed using Cook Mane Method	64
3.9.1	Correction for the maximum speed	68
3.10	The Model Description	73
3.11	Development of a software program to predict roof blown-off	74
CHAPTER FOUR: RESULTS AND DISCUSSION		75
4.1	Survey Results.	75
4.1.1	Age of Buildings	76
4.1.2	Roofing Systems	76
4.1.3	Roof Designer	76
4.1.4	Roofing Sheathing Materials	77
4.1.5	Major Inadequacies	77
4.1.6	Roof Truss Materials	78
4.1.7	Roof Failures	79
4.1.8	Indices of Roof Failures	80
4.2	Experiments Result	90
4.2.1	Moisture Contents	90
4.2.2	Corrosion Tests	91
4.2.3	Temperature Fluctuations	92
4.2.4	Effects of Interface gaps	96
4.3	Model Validation	96
4.3.1	Design Speed	96
4.3.2	Effect of Angle of Attack	96

4.3.3	Effect of Topographical Location	97
4.3.4	Effect of Roof Geometry	97
4.3.5	Effect of Pitch Angle	98
4.3.6	Effect of Courtyard	98
4.4	Remedial Measures	99
4.4.1.	Prevention of failure due to wind	100
4.4.1.1	Openings	100
4.4.1.2	Courtyard	101
4.4.1.3	Design of both rafter and purlin Spacing	101
4.4.1.4	Wall Plate	102
4.4.2	Prevention of Leakages	103
4.4.3	Remedies to Wood Decay	103
4.4.3.1	Moisture content regulation	103
4.4.3.2	Use of durable wood	104
4.4.3.3	Designing for Wood Decay Prevention	104
4.4.4	Rust prevention	105
4.4.4.1	Painting	105
4.4.4.2	Polymer coating	105
4.4.4.3	Zincalume Coating	106
4.4.4.4	Anodizing	106
4.4.4.5	Galvanizing	106
4.4.5	Maintenance	106
4.4.6	Construction	106
4.4.6.1	Joints	106
4.4.6.2	Installations	110
4.4.7	Roof overhang	111
4.4.8	Drainage	112
CHAPTER FIVE: CONCLUSION AND RECOMMENDATIONS		113
5.1	Conclusions	113
5.2	Recommendations	114

REFERENCES
APPENDICES

115
120

UNIVERSITY OF IBADAN

LIST OF FIGURES

Figure No.	Description	Page
2.1	Fink Truss	6
2.2	Pratt Truss	6
2.3	A House with Side Gable Roof	27
2.4	A House with Front Gable Roof	28
2.5	A House with Cross Gable Roof	28
2.6	A House with Shed Roof	29
2.7	A House with Saltbox roof	29
2.8	A House with Gambrel Roof	30
2.9	A House with Simple Hip Roof	31
2.10	A House with Pyramidal Hip roof	32
2.11	A house with Cross-hipped roof	32
3.1	Map of Nigeria Showing Study Area	41
3.2	Details of nailed joint subjected to loading.	45
3.3	Algorithm for the Roof Blow-off Model	47
3.4	Building Topographical Location	49
3.5	Elevation View of Hip Roof	53
3.6	Projected Area of Wind Attack	56
3.8	Hip Roof	57
3.7	Gable roof	57
3.8	Hip length	61
3.9	Load on Truss	69
3.10	Design Speed at Abeokuta	69
3.11	Design Speed at Ado Ekiti	69
3.12	Design Speed at Akure	70
3.13	Design Speed at Old Airport Ibadan	70
3.14	Design speed at New Airport Ibadan	71
3.15	Design Speed at Ikeja	71
3.16	Design Speed at Iwo	72

3.17	Design Speed at Oshogbo	72
3.18	Design Speed in South-Western Nigeria	73
4.1	Weight Loss in Nails	92
4.2	Induced Stress in Truss Member	98
4.14a	Bad fixing of wall plate	102
4.14b	Correct fixing of wall plate	102
4.15a	Butt Joint	107
4.15b	Scarf Joint with Plate	107
4.16a	Joint with eccentricity	108
4.16b	Joint with no eccentricity	108
4.17a	Rafter with no wedge	109
4.17b	Rafter with wedge	109
4.18a	Rafter with webs	110
4.18b	Rafter with no web	110
4.19	Installation of Roof Rafters	111

LIST OF PLATES

Plate No.	Description	Page
2.1	Roof assembly Showing Truss and Sheathing	7
2.2	A Thatched Roof	14
2.3	Shingles	15
2.4	Slate Roof	15
2.5	Roof Tile	16
2.6	Zinc Metallic Covering	17
2.7	Building with flat Roof	25
2.8	Steep Roof	26
2.9	A House with Gable Roof	27
3.9	Hip Length	59
4.1	Roof Blown-off	83
4.2	Sheet Removal	84
4.3	Nail Withdrawal	85
4.4	Rust	85
4.5	Asbestos Colouration	86
4.6	Truss Damage	87
4.7	Wood Decay	87
4.8	Leakages	88
4.9	Open lap	89
4.10	Roof Sagging	90

LIST OF TABLE

Table No.	Description	Page
2.1	Roofing Cost as a Percentage of Total Cost of New Building Project	23
2.2	Roofing Cost as a Percentage of Total Cost of Building Rehabilitation Project	23
3.1	Location Distribution of Roofs Surveyed	42
3.2	Relationship of full Protection with slope of Hill	52
3.3	Calculation of the Center of Pressure of the Roof	53
3.4	Calculation of the Areas of Hip and Gable Roof	58
3.5	Maximum Annual Speed at Abeokuta	58
3.6	Best Fitting Lines for Eight Stations in Western Nigeria	66
3.7	Maximum wind speed in Western Nigeria at Different Desired Lives and Different percentages of Risk	68
	Maximum wind speed in Western Nigeria ($VD_{max} = 90.88\text{Km/hr}$) at Different Desired Lives and Different percentages of Risk	68
4.1	Age distribution of Buildings	75
4.2	Distribution of Roofing Systems	76
4.3	Distribution of Roof Designers	77
4.4	Roof Sheathing Materials	77
4.5	Major Inadequacies	78
4.6	Roof truss materials	78
4.7	Distributions of roof failure patterns	79
4.8	Indices of Roof Failures	80
4.9	Roof Blown-Off Pattern in the Year	82
4.10	Roof Blown-Off Pattern Based on Topography Location	82
4.11	Blown-Off Based on Roof Geometry	82
4.12	Rural- Urban Pattern of Roof Blown-Off	83
4.13	Results of Moisture Contents Determination	90

4.14	Weight Loss in Nail	91
4.15	Daily Temperature Variation in ⁰ c	93
4.16	Details of Expected Load and Joint Test Results	96
4.17	Precautionary Guide against Roof Failures	100

UNIVERSITY OF IBADAN

LIST OF APPENDICES

Appendix No.	Description	Page
1	Questionnaire	120
2	Climatic Data	122
3	Daily Wind Run (Km/Hr)	138
4	Moisture Content Determination	139
5	Effect of Water on Wire Nail Determination	141
6	Programming	142
7	Programming Instructions	151
8	Data Entry	153
9	Results	168
11	Survey Data Representation	174

ABSTRACT

The increasing incidences of roof failures especially blow-off in recent times in Southwestern Nigeria has become worrisome in view of the damage done to adjacent structures and danger posed to building occupants and owners. There is the urgent need to devise methods to curtail failures and minimize the incidences of blow-off. This study was designed to investigate the causes and patterns of roof failures, recommend curtailment measures and develop a model to predict roof blow-off.

Using purposive sampling technique, a survey of 3,780 roofs spread across Ekiti (450), Lagos (450), Ondo (360), Ogun (570), Osun (780) and Oyo (1,170) states was undertaken to establish the causes and patterns of roof failure. During the survey, timber samples at the point of roof construction (780), and those from failed (2000) and unaffected roofs (1000) were collected for moisture content determination in accordance with American Standard for Testing Materials (ASTM) D442 while the common nails used in construction were subjected to corrosion test in accordance with ASTM 1977. The integrity of nail joints was tested in accordance with ASTM 1761. Physical measurements of attic space and ambient temperatures, roof slopes, building dimensions and orientation were taken and combined with topography and courtyard effect to develop aerodynamic model to predict roof blow-off. The model was validated using post-model survey captured data. Data were analysed using descriptive statistics and regression analysis.

Causes of roof failures included poor workmanship (30.5%), materials inadequacies (18.6%), design errors (14.8%), roof geometry (14.0%), topographical location (11.8%), age and environment (10.3%). Timber's moisture contents were 12.0% to 24.0% during construction. Natural seasoning of these moisture contents to 7.0% in service, induced stresses on roof members. Temperature fluctuations between 20.0°C and 40.0°C promoted moisture condensation and dimensional changes in roofs' wooden members. Poorly fitted joints reduced joint load from 103.1 ± 8.3 kg to 82.6 ± 5.1 kg. Nail diameter reduced from 21 ± 0.2 mm to 14.7 ± 0.3 mm within 90 days of exposure to water indicating potential reduction in joint strength. Blow-off occurred when $0.75M_R - M_O \leq 0$; where M_R and M_O are resisting and overturning moments respectively. The model revealed that while gable roof could be adequate at the plain, hip roof with pitch angle between 40° and 60° would be appropriate on 5° and 10° slope hills respectively, with coefficient of multiple regression of 0.91 ($p < 0.05$). The model also revealed that optimum

pitch angle was 55° and presence of courtyard reduced the wake and drag effects on roof. There were no statistical differences between the roof blow-off model predictions and post model survey data. The overturning moments for the rest were also greater than the resisting moment but they did not experience blow-off because of adequate anchorage of the sill.

Roof failures in Southwestern Nigeria were caused by weakened joints resulting from corroded nails, interface gaps and wind effect. Remedial measures could include appropriate building orientation, proper anchorage, high pitch and adequate openings.

Keywords: Roof failure, Blow-off, Pitched Roof, Modeling, Southwestern Nigeria

Word Count: 497 words

UNIVERSITY OF IBADAN

CHAPTER ONE

1.0 INTRODUCTION

1.1 General Background

A roof has at various times and by various authors been given different definitions. While the World Book Encyclopedia (1995) defines it as the cover of any building including the materials that support it, Paton (2000) describes it as the exterior surface and the supporting structure on the top of a building or generally as the top covering of any object, and yet Ezeji (2004) defined it as a framework on top of a building comprising of steel, timber or concrete on which a covering material is placed.

Arising from these definitions, it can be deduced that a roof is the top covering and sustaining structure for a building. It comprises of structural and non-structural members, fasteners and covering materials. The structural members are the trusses, purlins and wall plates, while the non-structural members are the noggins and slats. The covering materials are the upper coverings and the ceilings. The roof is an integral part of a building that has its outer part directly exposed to the sun and other weather elements while its inner part encloses the attic space (Ezeji, 2004).

The World Health Organization (WHO) recognizes that the roof is one of the important requirements for a house to be considered suitable for healthy habitation (WHO, 2005). This is because while a house may be inhabited without some elements of buildings such as partition walls, beams or columns, a house without a roof is not conducive for human and even animal accommodation.

The protection and comfort which building roofs should provide to occupants, the contents of buildings and external walls are frequently threatened by failures in the roofing systems. The cost of repairs or a complete replacement of a failed roof could be enormous. These include cost of repair in terms of material and labour; the cost of alternative accommodation pending the repair of the roof; the cost of treatment for injuries sustained by persons that the roof has fallen on; the cost of treating ailments such as pneumonia to persons directly affected by roof failures; the cost of replacing property loss in the affected building and the trauma and psychological disorientation for those living within any building whose roof has failed.

The Southwestern Nigerian states where this research is carried out is a zone with bi-modal wind run pattern occurring in April and August (Adenekan, 2000). This zone, lying roughly between latitudes 7.41° and 9.08° to the north of the equator and within longitudes 3.29° and 4.27° to the east of the Greenwich meridian has been found to have strong wind gusting up to 75Km/hr associated with line squalls convective rainfall (Adenekan, 2000). Afolayan (2002) reported that the temperature of the zone is generally high throughout the year with temperatures ranging between 21°C and 37°C and with high rain intensity. There are many topographical and altitudinal variations in the zone that promote different climates within short distances from one another. These features favour roof failures and it is necessary to take precautions to guide against them (Adenekan, 2000)

1.2 Objectives

The objectives of this work are:

- i) To identify the types and causes of roof failures commonly experienced in Southwestern Nigeria,
- ii) To recommend ameliorating measures to minimize the incidences of roof failures, and,
- iii) To develop a model to predict roof blow-off

1.3 Justification

Roof failure is a common occurrence in several parts of Nigeria, and all categories of buildings in the different regions are affected. When it occurs, it does not only result in financial losses but, at times, in injuries and loss of human lives. The roof is an important component of any building and its total failure invariably renders the structure over which it is built uninhabitable. In many building failures, the roof is nearly always affected and may be the only component because of its exposure to the wind and other weather elements. Roof failures have social, economic and psychological consequences on the affected people. Owning a house provides social security, as the owner is not subjected to insults or intimidation by a landlord. This security could be lost when the roof of a building fails.

The cost of repairs of damaged roof could be enormous, because of the daily increase in the prices of roofing materials. The situation is even worse in rural areas where early replacement of damaged roofs become almost impossible due to low level of financial resources

available to building owners. Numerous Government-owned schools in rural areas have had their roofs blown off and left un-repaired for upwards of three years, reported cases included a block of six classrooms that was blown-off since 2005 and is yet to be repaired in Saint John primary school, Edunabon, Osun state (Oyebode,2006).

Delayed actions to replace collapsed roofs during the rainy season may lead to much greater damage to the wall structures which are mainly earth materials thereby exposing the contents of the house to damage. Whenever there is total failure of roofing system, it is often associated with dangers to other buildings and passersby. It also affects facilities such as electric lines. When roof fails especially when it is blown-off and the owner is not able to replace it on time, these will be followed by anxieties, pains and adverse emotional reactions. A great deal of these losses and inconveniences could be avoided if the conditions that lead to failure of the roofs were understood and precautions taken to guide against them were taken.

In the past, many attempts have been made to solve the problem of roof failures. These included the use of metal straps; construction of block wall on the roof and planting of wind breakers. These methods are not full proof as there are still records of damages even with these in place. The construction of wall on the roof makes roof to be susceptible to leakage because the roof/wall interface may not be adequately taken care of. Wind breakers, if too close to the house can be broken during wind storm and cause damage to the roof. An understanding of the effects of environmental factors and performance potential of materials of construction would be useful in the design and construction of appropriate roof structures.

These problems arising from roof failures are crucial in the development of any community and efforts must be made to minimize or where possible eliminate them. An understanding of the causes and patterns of failures of roofs is necessary to be able to achieve this and therefore, there is need for this research.

1.4 Scope of the Study

The study covers the roofs of all types of buildings in the Southwestern part of Nigeria comprising Ekiti, Lagos, Ogun, Ondo, Osun and Oyo States. It is to be carried out during the dry and the rainy seasons.

CHAPTER TWO LITERATURE REVIEW

2.0

2.1 General

The history of roof dates back to the existence of human beings on earth. The need for protection from weather elements made the early human beings to live in caves to protect them from the effects of inclement weather. They lived in valleys where shelter from winds was considerable and under trees for protection against the scorching sun. (Gniadzik, 1984)

Since the beginning of human existence, many roof styles have been developed and are still being developed to cope with the demands of materials, environmental and technological advancement. The first form of roof was leafy branches bent over the tree to reduce direct effects of rain and keep sun off, this progressed on to cutting down the branches and making a tent out of them; and by trial and error making them stand up and keeping the weather elements out by covering with more waterproof layers. Gniadzik (1984) reported that because of the few needs and simple fulfillment, “primitive man, who, looking for shelter built a hut (using wood as structural member) with a thatched roof”. The present forms of roofs are adaptations of the old roofing systems.

In the past, the traditional method of constructing a roof with sloping surfaces was to pitch the rafters usually of timber on either side of a central ridge with rafters bearing on the wall plate on the supporting walls (Barry, 1984). This type of roof construction was referred to as couple roof. The disadvantage of this type of construction was that the weight of the roof tended to spread the rafters and overturn the supporting walls. In order to prevent the rafters from spreading under roof load, there came the modification of couple roof to close couple with the use of nailed timber ties to the foot of pairs of rafters. To increase room up into the part of the roof, closed couple was further modified to collar roof where the ties were between pairs of rafters, one third the height of the roof up the wall plate. With stress grading timber allowing more accurate sizing of structural timber, the use of connector plates and factory prefabrications, majority of framed pitched roofs are at present constructed as trussed rafters. A trussed rafter is a triangular roof frame of rafters, ceiling joist and internal webs joined with connectors.

2.2 Components of a Roof

A roof consists essentially of two parts which are the truss and the covering material.

2.2.1 Truss

A truss is a framework on which a covering material is placed (Ezeji, 2004). All types of trusses have the same basic components and structure. The name "truss" describes a triangular design, which may range from a simple individual triangle to a large number of interconnected units. The outside framing members are known as chords, while the smaller internal connecting members are called webs. A point where the truss rests on a load-bearing wall is known as a bearing point (Scott, 2009). Roof trusses are used to carry and support the weight of the roof deck and any material used to cover the roof. This weight can be quite significant if clay or slate roof tiles are used, or it may be very light when used to support asphalt shingles or rolled roofing. The chords support the roof while the webs brace and stabilize the chords, aiding in the distribution of the load across the entire truss to the bearing walls on either side. Roof trusses must be properly constructed in order to guide against failures (Tom, 2009).

There are two basic types of trusses, namely: pitched or common truss and parallel chord truss or flat truss:

(i) Pitched Truss

The pitched truss, or common truss, is characterized by its triangular shape. The different arrangements in which these triangles are used determine the shape of the truss. Some common trusses are named according to their web configuration. Examples include fink or fan, pratt, dormer, attic, scissors, king post, queen post, bowstring, utility and raised chord. The chord size and web configuration are determined by span, load and spacing of trusses (Aasin, 2008).

(ii) The Parallel Chord Truss or Flat Truss

This consists of parallel top and bottom chords and it is often used for floor construction (Ezeji, 2004).

In some instances, a combination of the two types of trusses may be used giving rise to truncated truss which is used in hip roof construction.

Some trusses are shown in Figures 2.1 and 2.2

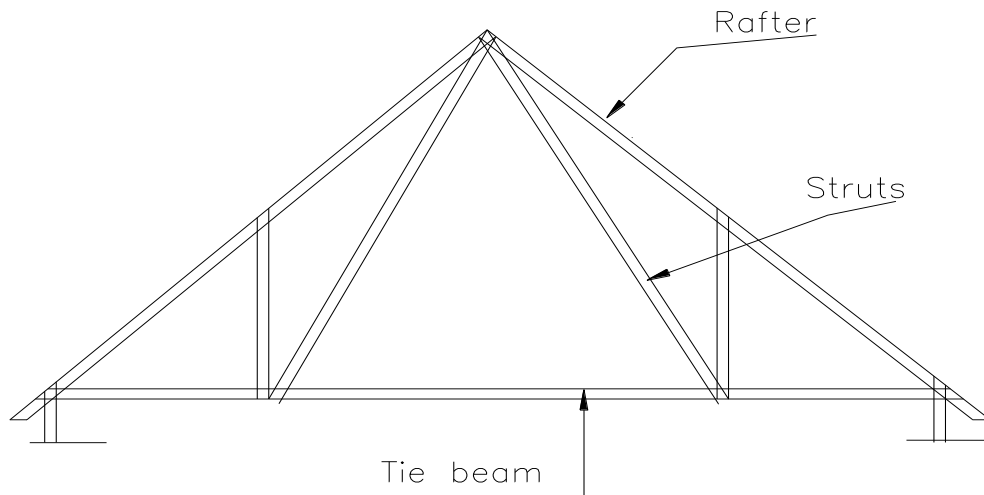

Figure 2.1: Fink Truss

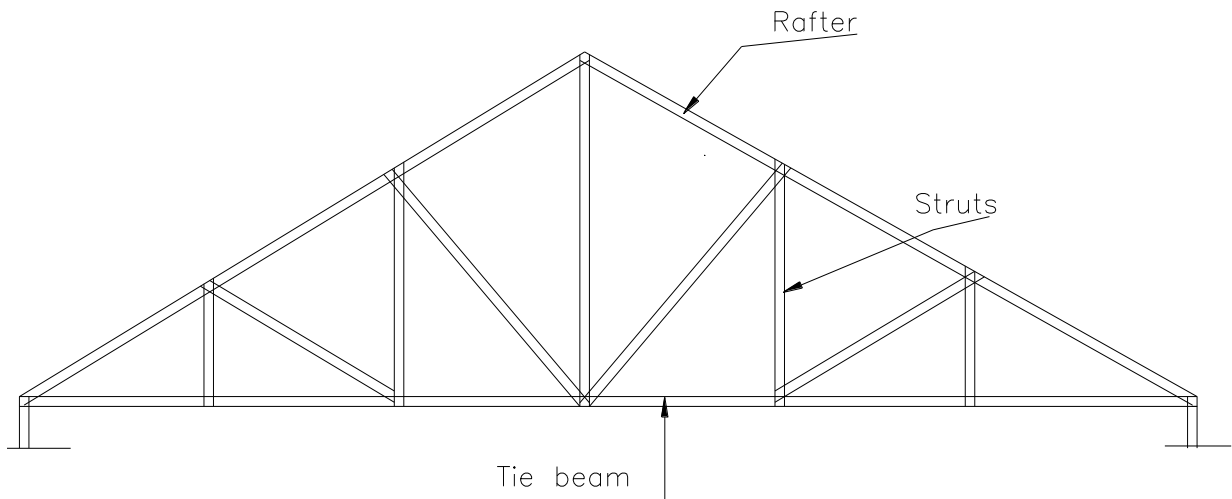

Figure 2.2: Pratt Truss

material or uppermost weatherproof layer of a roof shows great variation depending upon availability of material. The sheathing material apart from providing protection to the occupants of the building also assists in load distribution along the trusses (Aasin, 2008). The covering materials may range from banana leaves, straw or sea-grass to laminated glass, aluminium sheeting and pre-cast concrete. In simple ancient buildings, roofing material was often from vegetation, such as thatches, the most durable being sea grass with a life span of

2.2.2 The Roof Covering Material

The roof cover provides the shelter needed against inclement weather. The covering material or uppermost weatherproof layer of a roof shows great variation depending upon availability of material. The sheathing material apart from providing protection to the occupants of the building also assists in load distribution along the trusses (Aasin, 2008). The covering materials may range from banana leaves, straw or sea-grass to laminated glass, aluminium sheeting and pre-cast concrete. In simple ancient buildings, roofing material was often from vegetation, such as thatches, the most durable being sea grass with a life span of about 40 years (Ayorinde, 2002). The durability of a roof depends greatly on the engineering properties of the sheathing materials. Some materials that may prove to be adequate in some location may be inadequate in others (Aasin, 2008). This is usually taken into account in the choice of roof covering material in order to prevent roof failure. An example of a roof assembly is as shown in Plate 2.1



Plate 2.1: Roof Assembly Showing Truss and Sheathing

2.3 Historical Development of Roofing Materials

Roofing is an ancient art. Roofs have been constructed in a wide variety of forms including flat, pitched, vaulted, domed, or a combination of these as dictated by regional, technical, and aesthetic considerations. While the concept and general principle of roofing has

remained the same over the years, the roofing materials have witnessed much improvements and developments (Owen, 1985). Roofs have developed from the simple sticks tied at the tops and covered with dried animal skin in the beginning to the plastic, timber, concrete and metallic domes of the present (Ezeji,2004). The traditional roof coverings are thatch and grass in most African countries. They keep buildings cool, they are cheap and do not require great skill to fix. They are not durable and require frequent maintenance and with low fire resistance. Because of the limitations of these roofing materials, a lot of technological developments have taken place and various roofing materials evolved (Aasin, 2008).

The present day materials of roof covering include wood shingles, roof tiles, sheet metals, zinc and asbestos. According to Watson (2009), wood shingles were popular throughout all periods of building history. The size and shape of the shingles as well as the detailing of the shingle roof differed according to regional craft practices. People within particular regions developed preferences for the local species of wood that most suited their purposes. Roskind (2009) traced the use of clay tile for roofing as early as the mid-17th century. Typically, the tiles were 3.7m X 1.7m with a curved butt. A lug on the back allowed the tiles to hang on the lathing without nails or pegs. The tile surface was usually scored with finger marks to promote drainage. Sheet metal in the form of copper and lead has also been used for roofing. Lead and copper which are sometimes used for church roofs, were most commonly used as flashing in valleys and around chimneys on domestic roofs, particularly those of slate. In areas where clay is in abundance, roofs of baked tiles have been the major form of roof. The casting and firing of roof tiles is an industry that is often associated with brickworks. While the shape and colour of tiles is regionally distinctive, tiles of many shapes and colours are produced commercially, to suit the taste and economy of the house owners.

In the 19th century, iron, electroplated with zinc to improve its resistance to rust, became a light-weight, easily-transported, waterproofing material for roofing. While its insulating properties were poor, its low cost and easy application made it the most accessible commercial roofing covering material world wide. Since then, many types of metal roofing have been developed. Steel shingle or standing-seam roofs last about 50 years or more depending on both the method of installation and the moisture barrier (underlay) used and are between the cost of shingle roofs and slate roofs (Warland,2000). In the 20th century a large number of roofing

materials were developed, including roofs based on bitumen (already used in previous centuries), on rubber and on a range of synthetics such as thermoplastic and fiberglass.

The metamorphosis of the roofing covering materials from the early thatch roof system to the present day materials such as sheet metal, cement tiles, wood shakes or shingles, traditional slate or ceramic tile, high-tech polymer membranes, green roofs, solar roofs, asphalt roll roofing, coal tar, asphalt-mop technologies, and concrete is partly accounted for by the desire to find a durable roof covering resistant enough to the forces of the environment (Olomola, 2002).

2.4. Roofing Materials

2.4.1 Materials for Truss

There are various materials available that are used in the construction of roof trusses. These include timber, cast iron/ or steel, raffia palm and reinforced concrete.

2.4.1.1 Timber

Timbers occur naturally as trees of large sizes and different species with varying texture and strength and hence durability (Norman, 1967). Timber lends itself to a great variety of roof shapes. The timber structure can fulfill an aesthetic as well as practical function. Wood has a great disadvantage of being non-fire resistant and also prone to decay but these can be curtailed by due treatment. One of the reasons for its popularity in roof truss construction is that, it could easily be shaped with hand tools and only requires specialized equipment to process at the early stage. Although most of them find use in construction, only a few of them are used in roofing; as many of them are susceptible to dry rot and other defective conditions such as insect attack. Some popular roofing timber species in the tropics are; *Nauclea didderrichii* (Opepe), *Gossweilerodendron balsamiferum*(Agba), *Nesogodonia papaverifera*(Oro), *Terminalia ivorensis* (Afara), *Confluea grandiflora* (Apado), *Khaya ivorensis* (Mahogany), *Melicea excelsa* (Iroko), *Cordia millennii* (Omo), *Ceiba pentandra* (Araba), *Erythrophloeum suaveolens*(Erun), *Piptadeniastrum africanum* (Agbonyin), *Lovoa trichiloides* (Akoko igbo), *Tectona grandis*(Teak), *Triplochiton scleroxylon* (Arere) , *Holoptalea grandis* (Ayo), and *Anogeissus leiocarpus*(Ayin) (N C P 2 1973). Adesogan (1997) reported that Omo (*Cordia millennii*) and Afara (*Terminalia ivorensis*), due to their strong structural properties are the most commonly used wood for roof trusses in South Western Nigeria. He also reported that the use of lesser

quality wood in building project is in practice as a result of dwindling wood supply and high cost of procuring good quality wood.

a) More Advantages of Wood as a Building Material

The various reasons which are responsible for the wide use of wood as a construction material have been highlighted by Panshin and de Zeeuw (1977), Mettem (1986) and Pettit (1980) to include the following:

(i) Wood can be worked upon to produce a variety of shapes and sizes with greater diversity of unique characteristics than are found in other structural materials.

(ii) Wood may be cut and worked with various shapes with the aid of simple hand tools or power driven machinery therefore lending itself to conversion both in the factory and on site.

(iii) It can be joined with nails, screws, bolt and connectors all of which require the simplest kind of tool and provide strong joint. It can also be joined with adhesives to produce continuous bond over the entire surface to which they are applied and develop the full shear strength of wood thus providing a means of fabricating wood members of deferring shapes and almost unlimited dimensions. When joined, it won't affect the strength of the wood such as in large trusses, laminated beams. Jointing is impossible in concrete and there is distortion in steel during welding.

(iv) Wood structures can be designed to carry impact loads that are much greater than those they can sustain under static loading. This is in contrast with steel and concrete for which low increase is allowed under similar conditions. This exceptional impact strength of wood gives it a considerable mechanical and economical advantage for structures designed to resist earthquake or for situation where abrupt loads are imposed. Unlike steel, wood also possess excellent vibration damping characteristics, a property of utmost importance in bridges and other structures subjected to dynamic loads.

(v) Dimensional changes that take place as a result of rise in temperature are less significant in wood construction than they are in construction utilizing metal steel members. When heated, wood expands across the grains as much as or than metals but only little in longitudinal direction

which is important in construction. The increase in dimension with rise in temperature is frequently balanced by a considerable degree of shrinkage caused by drying with corresponding increase in strength. There is no such compensating effect in metal structural members which expand and lose strength progressively when heated.

(vi) Wood is a good safety element in that, whilst combustible, rate of burning is known and therefore permits time for evacuation of the premises. "Timber frame house design guide" quotes an 8" x 8" (200mm x 200mm) column withstanding fire up to 1200⁰C for an hour or more compared with an equivalent load bearing steel section which collapses in 10 to 12 (ten to twelve) minutes.

(vii) Wood has the advantage of light self weight and of being a dry form of construction.

(viii) Wood retains its cohesion characteristic when exposed to certain protracted conditions for length of time while steel rusts or corrode in presence of moisture.

(ix) Defects generally can be detected by visual means without the use of microscope and the defects removed. This is impossible with steel and concrete.

(x) Wood is renewable either through accelerated means or naturally.

(xi) Wood is a poor conductor of heat and is warm to touch.

(b) Adverse factors of the use of wood

Wood with its multipurpose utilities has some adverse effects when use as a material of construction. These adverse effects as identified by Brough (1964), Panshin and de Zeeuw (1980), and Mettem (1986) include.

(i) It's relatively low fire resistance being a combustible material. The rate at which it loses strength is strictly proportional to the rate at which it is consumed by fire.

(ii) The wood hygroscopicity which if unchecked has a considerable effect on its dimensional stability.

- (iii) Wood is susceptible to degradation by fungi, insects and weather elements.
- (iv) Wood's high variability in strength within and among species.

(c) Protective measures

There are a number of protective measures applicable to wood members in service. Like all other materials, both the mechanical and other properties of wood can be satisfactorily improved to meet the required functional purpose. Some of the protective measures in common use include the following:

(i) Painting

Paints are generally used to provide a durable and colourful protective coating for their vulnerable surface. Conditions of painting are often far from ideal, particularly outside, but it is essential that the surface to be painted is dry, clean and free from grease. A variety of colours are available but it is essential to ensure that the paint selected is suitable for the work it has to do whether internal or external.

(ii) Applying preservative

Preservation is the term given to those solutions designed to protect timbers from insect or fungal attack. Timber preservation within the timber trade and allied industries is now accepted as an integral part of wood processing. For many years it has been possible to have structural timber treated with preservative under pressure to ensure deep penetration. Any untreated surfaces which are exposed during working are then brush-coated.

- (iii) Treatment with chemicals is one way of protecting wood structures against fire hazard.

2.4.1.2 Concrete

Reinforced concrete beams are also used as roof trusses. When used, the concrete is placed in-situ with stud built-in to receive the roof sheathings. The advantage of this type of construction is that it can span longer lengths than timber trusses and many joints can also be

avoided. Some of the advantages of concrete trusses are its resistance to decay, blown-off and warping (Chukwuneke, 2000).

2.4.1.3 Steel

Steel is a metallic material composed mainly of iron and carbon. It is available in different sections such as the I-section and L-section, which are principally used in the construction of skeletal roof framework in large spaces such as auditorium, warehouses and factories.

With continuous improvements in steel girders, these became the major structural support for large roofs, and eventually for ordinary houses as well. Another form of girder is the reinforced concrete beam, in which metal rods are encased in concrete, giving it greater strength under tension (Cotz, 2000). The mechanical properties of steels such as tensile strength, yield stress (or proof stress) or hardness give steel advantage over other truss materials. These properties give a guarantee that steel material can be correctly specified with little variance in properties required unlike timber of the same species that can vary in properties (Atlas Steels Australia, 2010)

2.4.2 Materials for Roof Coverings

Many materials have been used as roof covering and these include thatch, shingles, slate, tiles, metals, concrete, thermosetting plastic and modified bitumen, solar roof, asphalt, bituminous felt, asbestos (Chalton *et al*, 2002).

2.4.2.1 Vegetative Coverings

Vegetative materials in forms of leaves, grasses, palm fronds and tree barks are among the earliest materials used for roof covering and till date, they are still the predominant materials in many farming communities in many developing countries. Bamboo is used both for the supporting structure and the outer layer where split bamboo stems are laid turned alternately and overlapped. In areas with an abundance of timber, wooden shingles are used, while in some countries the bark of certain trees can be peeled off in thick, heavy sheets and used for roofing (Koenigsberger *et al*, 1974). This type of roofing (Plate 2.2) system keep buildings cool under tropical climate, they are cheap and do not require great skill for installation. They are not durable and require frequent maintenance and can easily catch fire.



Plate 2.2: A Thatched Roof

2.4.2.2 Shingles

Shingle is a thin flat tile usually made of wood, which is fixed in rows to make a roof covering. According to Zakopane (2010), wood shingles (Plate 2.3) were popular in areas with abundance of high quality timbers throughout all periods of building history. The size and shape of the shingles as well as the detailing of the shingle roof differed according to regional craft practices. People within particular regions developed preferences for the local species of wood that most suited their purposes. Shingles have been made of various materials such as wood, slate, asbestos-cement, bitumen-soaked paper covered with aggregate (asphalt shingle) or ceramic. Due to increased fire hazard, wood shingles and paper-based asphalt shingles have become less common than fiberglass-based asphalt shingles.

When a layer of shingles wears out, they are usually stripped, along with the underlay and roofing nails, allowing a new layer to be installed. An alternative method is to install another layer directly over the worn layer. While this method is faster, it does not allow the roof sheathing to be inspected and water damage, often associated with worn shingles, to be repaired. Having multiple layers of old shingles under a new layer causes roofing nails to be located further from the truss, weakening their hold. The greatest concern with this method is that the weight of the extra material could exceed the design load capacity for the roof structure and cause collapse (Owen, 1985). Sometimes a protective coating could be applied to increase the durability of the shingle such as a mixture of brick dust and fish oil, or a paint made of red iron oxide and linseed oil.



Plate 2.3: Shingles

2.4.2.3 Slate

Slate is obtained, usually by blasting, from both open quarries and mines. Large blocks are cut up by circular saws into smaller blocks that are splitted by chisel and mallet along the planes of cleavage. The slates thus obtained are trimmed to the market sizes (Oxley and Poskett, 1977). Labine,(1975) reported that evidence of roofing slates (Plate 2.4) have been found among the ruins of mid-17th century Jamestown. He stressed further that because of the cost and the time required to obtain the material, the use of slate was initially limited. Slate was popular for its durability, fireproof qualities, and aesthetic value. Because slate was available in different colors (red, green, purple, and blue-gray), it was an effective material for decorative patterns on many 19th century roofs especially the gothic and mansard styles.

Often, the first part of a slate roof to fail is the connector which corrodes, allowing the slates to slip. Because of this problem, fixing nails made of stainless steel or copper are recommended, and even these must be protected from the weather (Henry, 1977)



Plate 2.4: Slate Roof

2.4.2.4 Tiles

In areas where clay is available in abundant quantities, roofs of baked tiles (Plate 2.5) have been the major material for roof covering. The casting and firing of roof tiles is an industry that is often associated with brickworks. These materials are highly subject to failure by embrittlement. Concrete roofing tiles are covering materials made from fine concrete, comprising cement and fine aggregates. Sometimes colouring pigments are added in the production process to improve on its aesthetics. The tiles may be corrugated or non-corrugated. Common sizes are in the range of 600mm x 600mm and 600mm x 300mm. Single tile is shown in Plate 2.5a while a roof that was constructed with tile is shown in Plate 2.5b

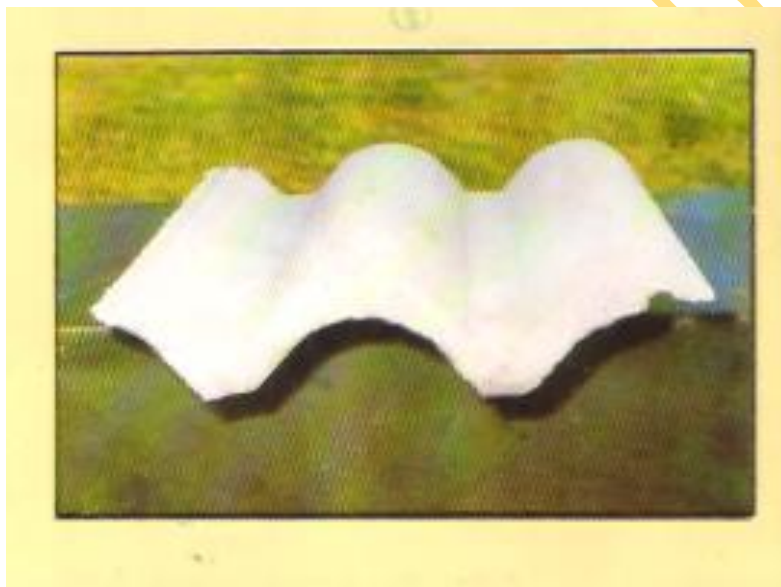

Plate 2.5a: Roof Tile



Plate 2.5b: Roof constructed with Tile

2.4.2.5 Metallic Coverings

Metallic coverings (Plate 2.6) are in great demand in places with high temperatures especially in the tropics where there is no need for house warming. These coverings include zinc and aluminium

(i). Zinc:

This is light grey non-ferrous metal made into corrugated sheets. It is a popular roof cladding material in the tropics. Their main disadvantage is that they often require ceiling to keep the building reasonably cool in hot weather and they often rust.

(ii). Aluminum:

Aluminum alloy sheets are similar to zinc but are cooler in hot weather and lighter to handle. They are corrosion resistant and of reasonably good appearance



Plate 2.6: Zinc Metallic Covering

In the 19th century, iron, electroplated with zinc to improve its resistance to rusting, became a light-weight, easily-transported, waterproofing material for roofing. Although the insulating properties of this material were poor, its low cost and easy application made it the most preferred commercial roofing world wide (Olomola, 2004).

2.4.2.6 Concrete:

Concrete is a man-made composite. The major constituent in terms of volume is the aggregate of which there are two types (coarse and fine). Natural aggregates are sand and gravel or crushed stone while artificial aggregates may be blast furnace slag. The cement produces the binding medium of the aggregates through the chemical reaction between cement and water

(hydration). There are different criteria that guide the choice of grade, sizes and form of concrete members in a building. When used in roofing, the design is similar to that of floor except that the load imposed is extremely small compared to load on floors (Minjinyawa, 2010)

2.4.2.7 Bitumen

Bitumen is a black or brown compound of hydrocarbons commonly obtained from the industrial refining of crude petroleum although it could also occur naturally in association with mineral aggregate. It is substantially non-volatile and softens gradually when heated. Bitumen has many constituents, which make it possess waterproofing properties. Its common use in roofs is as a result of the desire to protect roofs from water deterioration which bitumen is capable of providing (Aasin, 2008)

2.4.2.8 Asphalt:

Mastic asphalt which meets the specification of the British Standard BS 1162 or BS 988 is highly suitable for covering concrete roof slabs. However, because of its high coefficient of thermal expansivity, it is generally necessary to separate asphalt from any substrate by an isolating membrane or sheathing (Longman and Jenik, 1987). Two layers of asphalt are always necessary and the total finished thickness should not be less than 20mm with joints staggered at least 150mm laps.

2.4.2.9 Bituminous Felt:

Bitumen when used to impregnate mass of organic or inorganic fibres, form materials known as Bituminous felt (Longman and Jenik1987). These materials are of different types depending on the base materials. Bituminous felt finds use essentially in water proofing in roofs. Four main types of roofing felt are available and, these are:

(a). Organic fibre base

This base is very flexible and low cost but is liable to organic decomposition under sustained exposure to weather. Examples are: Rag felt, jute felt and Hessian felt (Longman and Jenik1987)

(b). Asbestos fibre base

This is relatively inert and provides improved fire resistance. It is however prone to dimensional instability under long-term exposure to weather.

©. Glass fibre base

This has a good dimensional stability under exposure and is inert. It is most expensive and has low impact strength e.g. glass cloth felt (Longman and Jenik1987)

(d). Plastic fibre base

This is also relatively inert and has very good elastic properties but has poor thermal stability. It also adheres poorly to bitumen. An example is the Polyester fleece felt (Longman and Jenik, 1987).

2.4.2.10 Asbestos Sheets:

These are corrugated roofing sheets made from two basic raw materials; cement and asbestos, with asbestos forming about 15% of the total weight (Malcom, 1991). Asbestos is a fine fibrous textured incombustible material occurring in igneous or metamorphic rocks. The layers of the mixed materials are united under high pressure during manufacturing process.

The advantage of asbestos roof is that it keeps the house cool, not requiring ceilings and also has high fire resistant. The main disadvantage is that they are fragile and also asbestos dust can be a health hazard if it is inhaled

2.5 Functions and Functional Requirements of Roof

2.5.1 Functions of Roofs

The roof is an important component of any building and its failure most often renders the structure over which it is built uninhabitable. In many building failures, the roof is nearly always affected and may be the only affected component because of its exposure to weather elements. Roof perform many roles in a building; the principal one being shelter and aesthetics. Roof could also perform special requirement purposes such as sound insulation.

(a) Shelter

The roof has the primary function of sealing the building against the weather and to maintain the seal over a considerable number of years (McKay, 1969). Depending upon the nature of the building, the roof may also offer protection against heat, sunlight, cold and wind. Other types of structures, for example, a garden conservatory, might use roofing that protects against cold, wind and rain but admits light. A verandah may be roofed with material that protects against sunlight but admits the other elements (Walton, 2001).

(b) Aesthetics

Roof functions are not only sheltering but are also aesthetics and contribute much to the integrity of buildings. Roof, by forms, define the styles and, by their decorative patterns and colours, contribute to the beauty of the buildings (Ezeji, 2004). To a large extent, the design of a roof influences the appearance of a building, which together with other factors contributes to the beautification of the environment. Apart from the beauty arising from the geometry, roof coverings also add to the beauty of the house.

(c) Special requirement functions

Roofs are often designed to meet with the required resistance to sound transmission. Where sound insulation is a critical requirement, concrete or built-up roof whose mass will afford appreciable sound reduction are always used. Other special requirement functions of roofs include generation of electricity by solar roof, prevention of radio active emission in radioactive protection buildings and in greenhouses for crop production.

2.5.2 Functional Requirements of Roof

To effectively serve the purpose for which they are designed and constructed, roofs must possess a number of qualities. Some of the qualities are stability, strength, durability and weather resistance.

(a) Strength and stability

The roof framework should be strong enough to support its own weight and in addition support the imposed loads from snow, wind and human traffic during maintenance. The strength

and stability of a roof depend on the characteristics of the materials from which it is constructed and the way the components are put together (Gniadzik, 1984).

(b) Weather Resistance

Two major types of exposures are recognized for roofs and their structural members. These are the interior and exterior exposures. With interior exposures, the roof is limited to cyclic atmospheric variations of water vapour and temperature occurring within the structure over which the roof is placed. On the other hand, exterior exposure brings the roof in contact with environmental conditions of rainfall, sunshine and other weather elements. A roof must be able to withstand these factors in order to perform its functions (Addai and Amoah-Mensah 1998).

(c) Durability

Roofs are considered durable if they retain their strength and other properties over a considerable period of time. Roof should be able to withstand atmospheric pollution, frost, and other harmful conditions to which they are exposed (Ivor, 1981). The durability of a roof depends largely on the ability of the roof covering to exclude rain from outside. Persistent penetration of water into the roof structure may cause decay of timber, corrosion of steel or disintegration of concrete. The durability of a roof is a matter of concern because the roof to a great extent determines the continuous functioning of the other building elements. To ensure durability, routine preventive roof maintenance can protect buildings from damaging weather, extend the life of the roof system, and decrease building life-cycle costs (Watkins, 2005).

(d) Fire Resistance

This is defined as the period of time (usually expressed in hours) over which a material can be exposed to open fire and withstand the effect without losing its structural properties. Roof and its coverings must be designed to have adequate resistance to damage by fire, and against spread of flame to allow the occupants of the building to escape to safety during fire outbreak. The ideal fire resistance of a roof should range from 0.5 to 6 hours (Barry, 1984).

(e) Thermal properties

Solar radiation is a major source of heat into a building especially in tropical climate. A good roof should be able to regulate the solar radiation into a building. The thermal coefficient of a roof (including the ceiling), should not be more than $0.35\text{w/m}^2\text{ }^0\text{C}$ (Barry, 1984). Some roofing materials, particularly those of natural fibrous material, such as thatch, have excellent insulating properties. For those that do not, extra insulation is often installed under the sheathing materials. Some dwellings have a ceiling installed under the structural member of the roof. The purpose is to insulate against heat and cold, noise, dirt and often from the droppings and lice of birds who frequently choose roofs as nesting places. Other forms of insulation are felt or plastic sheeting, sometimes with a reflective surface, installed directly below the tiles or other material; synthetic foam batting laid above the ceiling and recycled paper products and other such materials that can be inserted or sprayed into roof cavities.

2.5.3 Economic Importance of Roof

Warland (2000) reported that the sheathing membrane of roof structure provides a good protection for a building because of its umbrella action in quickly removing the rain water and shielding from sunshine and other weather elements. Therefore roof damage could result in loss of fortunes or valuable properties. Delayed actions to replace collapsed roofs may lead to much greater damage to the wall structures thereby exposing the contents of the structure to pilferage.

The cost of repairs of damaged roof could be enormous not just because of the daily increase in the prices of roofing materials but the special skill required for roofing is also expensive. For example, as at 2008, while other artisans such as mason, iron benders and painters are employed at a cost of N1, 500.00 for a day job, carpenters are paid between N2, 500.00 and N3, 000.00 per day job depending on their experience in roof construction. Tables 2.1 and 2.2 are the outcome of the case studies of some selected institutions in Southwestern Nigeria. They show that the cost of roofing a new building project constitutes between 12% and 20% of the total cost of the project while that of rehabilitation work will take between 21% and 46% of the total rehabilitation cost.

Table 2.1: Roofing Cost as a Percentage of Total Cost of New Building Project

Project Name	Contract sum	Roofing Cost	Percentage
Construction of Telephone Operators' Office University of Ibadan	#554,516.00	#67,700.00	12.21
Construction of Estate Office University of Ibadan	#16,906,765.00	#2,334,930.00	13.81
Construction of Students Affairs Office University of Ibadan	#10,625,307.00	#1,777,775.00	16.73
Construction of C.I.C.S Building University of Ibadan	#27,102,575.00	#4,415,599.00	16.29
Macarthur/ICT Building University of Ibadan	#19,603,752.00	#4,100,730.00	20.09

Source: Works and Maintenance Department, University of Ibadan (2007)

Table 2.2: Roofing Cost as a Percentage of Total Cost of Building Rehabilitation Project

Project Name	Contract sum	Roofing Cost	Percentage
Renovation of UPE Building Bowen University, Iwo	#3,576,613.33	#1,104,900.00	30.89
Renovation of Agric Hall Bowen University, Iwo	#416,348.87	#105,750.00	25.40
Renovation of Maclean Hall Bowen University, Iwo	#467,727.27	#188,000.00	40.19
Renovation of Science Education Hall Bowen University, Iwo	#403,514.55	#87,000.00	21.56
Renovation of Principal's House Bowen University, Iwo	#2,500,000.00	#1,150,000.00	46.00

Source: Works and Maintenance Department, Bowen University Iwo (2008).

2.6 TYPES OF ROOFS

The two basic criteria for categorising roofs are the pitch angle and the shape of the roof (Barry, 1969).

2.6.1 Classification According to Pitch of the Roof

Roofs are often classified as pitched or flat roof. The pitch of a roof is defined as the ratio of the rise to the span of the top chord. The pitch is sometimes expressed in degrees or fractions. Opinions differ as to what angle of slope differentiates flat from pitched roofs. While some regard any roof not more than 10^0 (Seeley, 1974; Owen, 1972) slopes as flat, others consider that roofs of more than 5^0 slopes should be regarded as pitched (Walton, 1974).

(a) Flat Roofs

Flat roofs are roofs with slope angle ranging from 0^0 to 10^0 (Seeley, 1974), an example of which is presented in Plate 2.7. It may terminate with or without eaves. Vila (2007) reported that flat roofs have historically been used in arid climates where the rainfall is light and drainage of water off the roof is not important. He further reported that flat roofs were in widespread use in the 19th century, when new waterproof roofing materials and the use of structural steel and concrete made them more practical. If adequate slopes are provided and good design principles are followed, flat roofs may prove the only practicable form of roof for large buildings or those of complicated shapes. Flat roofs may also be cheaper than pitched roof and easy to maintain. A flat roof, however, has the following disadvantages

- (i) It is a poor thermal insulator; it is very cold in the cold weather and unbearably hot in hot weather. This is as a result of the small or no attic in this type of roof.
- (ii) It tends to give a building the appearance of being unfinished (Barry, 1969)



Plate 2.7: Building with flat Roof

(b) Pitched Roofs

Pitched roofs are roofs with one or more of the sections at a pitch or slope of more than 10° to the horizontal. A typical example of pitched roof is shown in Plate 2.8. The most common of this category is the symmetrical roof pitched to a central ridge with equal slopes (Fullerton, 2005). Sloping roofs exist in many varieties. The simplest is the lean-to (or shed) roof, which has only one slope. A roof with two slopes that form a triangle at each end is called a gable roof. A hipped (or hip) roof has sloping sides and ends meeting at inclined projecting angles called hips. Some types of roofing materials such as thatch require a steep pitch in order to be waterproof and durable. In general, the pitch of the roof is proportional to the amount of precipitation expected in the location. Houses in areas of low rainfall frequently have roofs of low pitch while those in areas of high rainfall and snow have steep roofs.



Plate 2.8 Steep Roof

Source: Field Survey

2.6.2 Classification According to Shape

On the basis of shape, roofs are generally divided into two major groups, namely gable and hip

(a) Gable Roof

Gable roof refers to the family of roofs characterized by the straight slope falling from the ridge to the eave, creating a peak or triangle on the side as could be found in Plate 2.9. A gabled roof has two slopes that come together to form a ridge or a peak at the top, each end looks like the letter A. Gable roof styles are derived from the simple ancient building practice of vertically leaning sticks or logs at an angle to form a triangular shelter. The gable roof is a very popular roof style for a number of reasons. It is relatively easy to build, sheds water and snow well because of the angle of pitch, provides for ventilation and is adaptable to a wide variety of house shapes and designs. With these attributes, the gable roof remains a quick, easy, cost-effective and therefore highly desirable roof type. (Kumar and Stathopoulos, 2000)



Plate 2.9: A House with Gable Roof

Gable roofs can be subdivided based on different criteria, which include

- (i) The location of the main entrance to the building relative to the gable end
- (ii) The slopes of both sides of the gable

Based on the location of main entrance relative to the gable end, gable roof can be side, front or cross gable while on the basis of slopes of both sides of the gable, gable roofs can be regarded as shed, saltbox and gambrel

(i) Side Gable

This type of roof locates the main entrance to the building on the non-gabled side of the building as shown in Figure 2.3

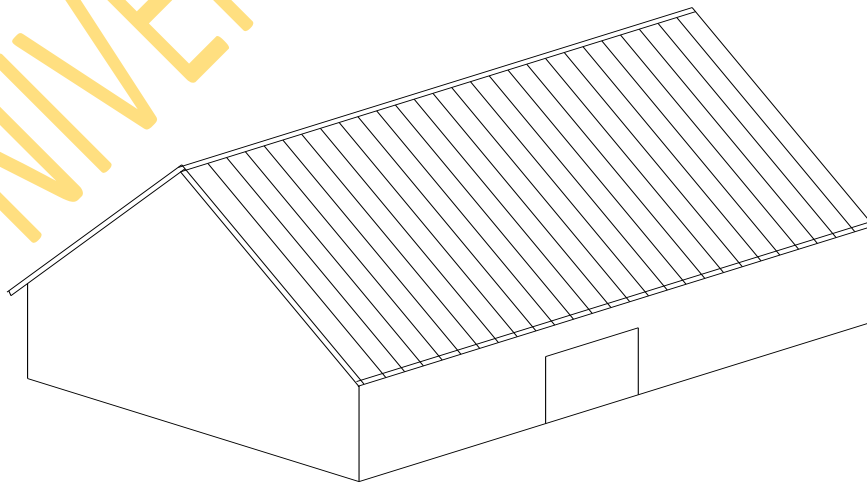

Figure 2.3: A House with Side Gable Roof

(ii) Front Gable

In this type of roof, the main entrance to the building is located on the gable side of the building as shown in Figure 2.4

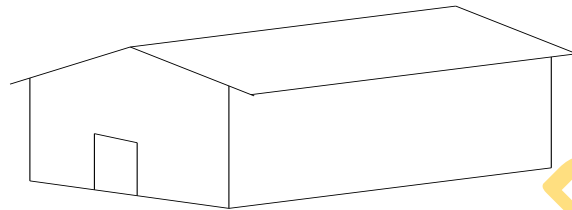

Fig 2.4: A House with Front Gable Roof

(iii) Cross gable

Cross gabled roof as shown in Figure 2.5 has additional sections or wings crossing perpendicular to the main section, meeting in a valley, each with its own peaked or gabled front of the building façade.

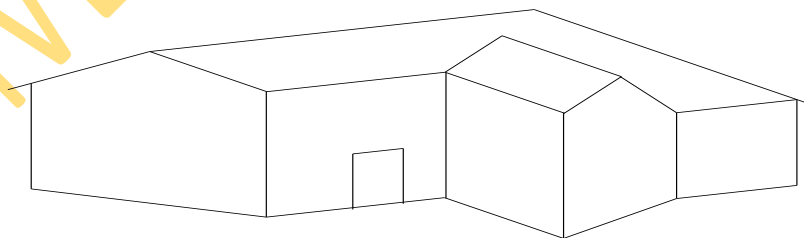

Figure 2.5: A house with Cross Gable Roof

(iv). Shed

Shed as shown in Figure 2.6 is a gabled roof with a single roof falling away from the main building. Shed roofs are often used for porches, additions, and raised roof sections



Figure 2.6: A house with Shed roof

(v) Saltbox

Saltbox as shown in Figure 2.8 is a gabled roof with asymmetrical roof faces. This asymmetry produces one facade that is two stories high dropping to a single story or story and one half on the opposite side of the building.

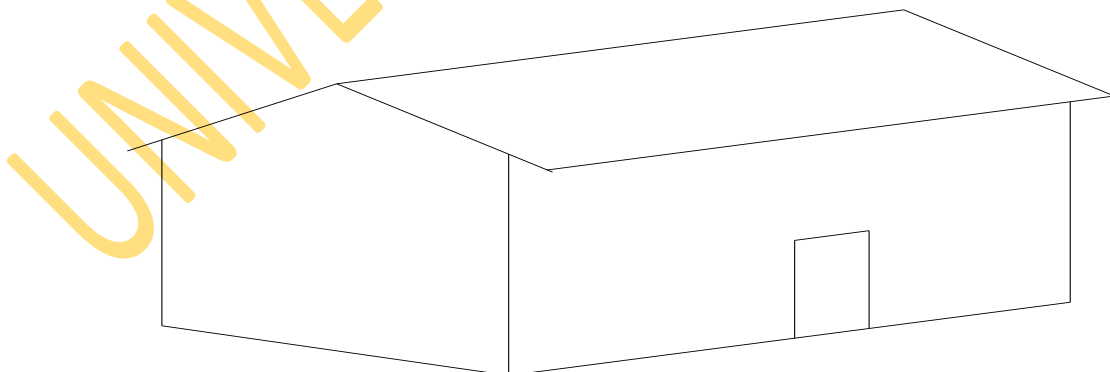

Figure 2.7: A house with Saltbox roof

(vi). Gambrel

This is a gabled roof that peaks at the ridge line and then falls away in a broad, low slope, breaks horizontally and changes to a steeper pitch. A gambrel roof has a broad upper story and side façade and is often used in barns. A typical example is shown in Figure 2.9

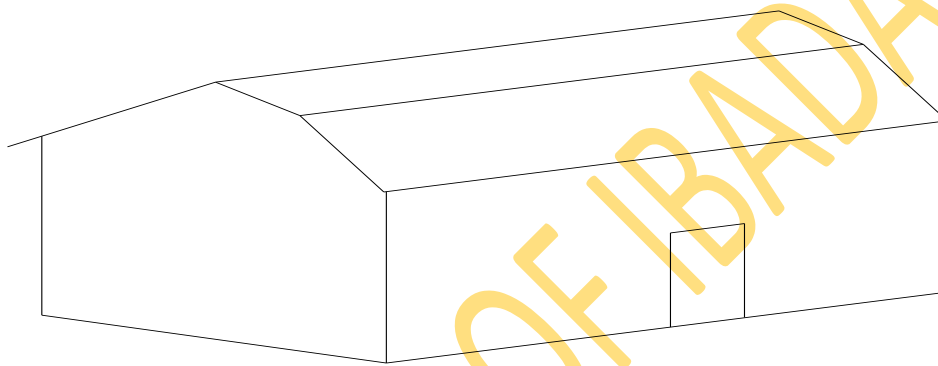

Figure 2.8: A House with Gambrel Roof

(b) Hipped Roof

A hip roof is one that slopes upward from all sides of the building. This family of houses avoids having a peak or triangle at the roof junction by breaking the roof plane along the slope line, allowing the roof to bend or warp around the house. Hipped houses have an even roof to wall junction all the way round the house and eaves on all sides. Villa (2005) reported that because of its aerodynamic properties and construction techniques, most hipped roofs will perform better in windstorms than a gabled roof. Hip roofs are more difficult to construct than gabled roofs, requiring more complex systems of trusses. Although the roof itself is harder to construct, the walls that carry the roof are easier to build, being all one level. One advantage of a hip roof is that it's all round eaves protect the walls from weather and help to shade the walls from the sun, thus reducing the power needed to cool the structure in warm climates. A gable roof does not shade the walls at the gabled sides.

A possible disadvantage of a hip roof compared to a gable roof is that there is less room inside the roof space and access is more difficult than that of gable for maintenance. There are three basic types of hip roof and these are simple, pyramidal and cross-hipped

(i) Simple Hip Roof

This is a roof where the entire four roof faces rise to a ridge across the top, often with broader faces across the front slope and narrower side sections as shown in Figure 2.9.

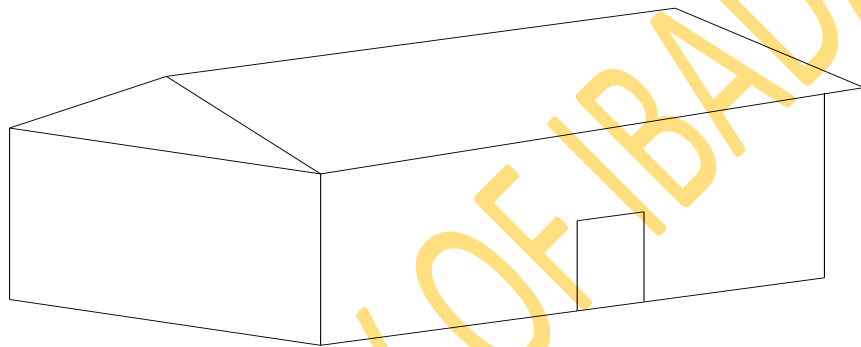

Figure 2.9: A House with Simple Hip Roof

(ii) Pyramidal Hip Roof

Pyramidal hip roof is a hipped roof where all four sides come to a point at the roof peak as shown in Figure 2.10

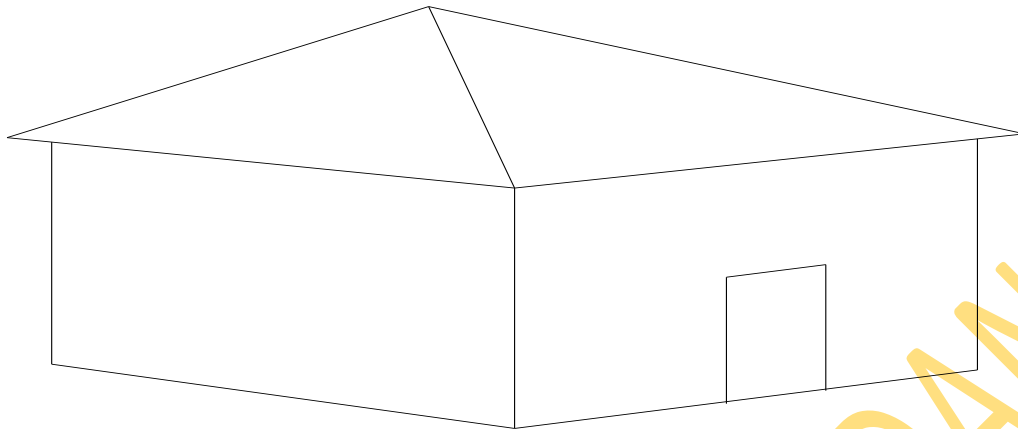

Figure 2.10: A House with Pyramidal Hip Roof

(iii) Cross Hipped Roof

Cross-hipped roof is a roof with multiple sections or wings that cross the main section, meeting in a valley, each with its own hipped profile (Figure 2.11)

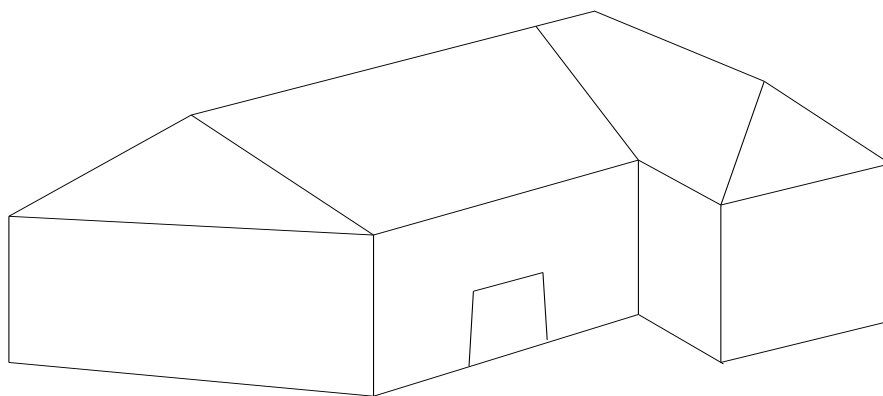

Figure 2.11: A House with Cross-Hipped Roof

2.7.0 Choice of Roof Type

The most appropriate form of roof structure for a particular building will depend but not limited to such factors as size and plan or shape of the building, appearance or aesthetic considerations, cost of construction, ease of effecting repairs, nature and magnitude of the loads that may be imposed on it, including the suspension of machinery, possibility of future alteration, lighting requirements and accommodation for services (Ezeji, 2004). Some of these factors are discussed below

2.7.1 Size and Shape of Building

The size of a building is the most influential factor on the choice of roof type. The span is fixed by the use to which the building will be put; since that will dictate the minimum area of unobstructed floor space required (Seeley, 1974). Oxley and Poskett (1977) reported that the minimum spans compatible with requirements of clear floor space should always be adopted in design. They also reported that the clear, internal height of the building is another important factor for consideration regarding the use of a building. For local domestic buildings, a height of 3m from floor to ceiling is the minimum. In industrial buildings, clearance must be provided for the installation and maintenance of plants, and the use of fork lifts. Much ancillary equipment is now hung from the roof, and provision of sufficient headroom below the equipment will govern minimum internal height.

2.7.2 Aesthetics

Roof is critical to basic house integrity, it gives house identity. The color and texture of the roof, its patterns of tone and shadow, lend character and personality to the home. A roof should of necessity be seen to be a natural part of the building, one that helps the building relate visually to its environment (Villa, 2009). Consequently, the best roof designs spring from the shape of the house and mesh with the overall style of the building. That is why certain roof shapes and roof coverings are associated with particular historical periods and designs, and even the most creative modern architecture selects a roof to harmonize with the overall structure. When modifying a house or adding on, it is important to be sensitive of the way the new roof fits into the existing design. The choice of roof type if properly made enhances the aesthetics of a

building. Aesthetics must not at any stage compromise the structural fitness. Aesthetics most times will prove pitched roofs as better alternatives for small buildings and flat roofs for large or irregular shaped ones (Ivor, 1981)

2.7.3 Cost

The cost of roof both in terms of installation and maintenance relative to the economy of the house owner, to a large extent, affects the choice of a roof type. Other factors being equal, economy is the prime consideration. Individuals or groups may afford steel roofing skeletons and aluminium sheets while others may only afford aluminium or zinc on timber skeleton. Often times, cost makes roof clients to compromise on quality of roofing materials for substandard materials.

2.7.4 Climatic Factors

The weather conditions of the environment in which a roof is to be erected is one of the important factors to be considered in the choice of a roof. The roof is directly exposed to rain, sunshine and other environmental conditions, therefore the shape and materials of the roof must be such that will be able to withstand the stresses from the environment. The roofing system that is commonly used in moderate climates often proves inadequate in the hot climates (Aasin, 2008). A flat roof which may be appropriate in an environment with light rainfall may not be suitable in an environment with heavy rainfall as this will encourage roof failures resulting from ponding.

2.7.5 Type of Trusses

The function of a truss is to transfer load from point of application to the supports as directly as possible. Thus for a concentrated load at the centerline of a span, a simple “A” frame is the most efficient. Like-wise, if only two equal and symmetrically placed concentrated loads are involved, a truss similar to the queen-post type is the most efficient. In both trusses, the load is transferred to the support directly through the sloping top-chord members without the need for web members (Jakkula and Stephenson, 1953).

Theoretically, the three basic types of trusses in order of relative efficiency are bowstring, pitched and flat. Architectural style, types of roofing material, methods of support of column

framing, and relative economy are the principal factors influencing the choice of trusses. This will invariably determine the side- and end-wall height, type of bracing requirements and roof shape (Burleson, 2005).

2.8 Roof Failures

Failure can be defined as any form of behaviour in the roof that seems to threaten the safety of the roof in terms of serviceability or which could lead to total collapse. There are three broad categories of failures; these are ultimate limit state generally connected with collapse, serviceability limit state connected with deflection and vibration, all other limit state connected with special requirements, for instance, aesthetics, fatigue, fire resistance, and water tightness (Chukwuneke,2000).

2.8.1 Ultimate Failure

This type of failure is the structural collapse of the roof, it may be slow structural collapse known as plastic failure or sudden failure. These types of failures are usually disastrous in nature and more widely publicized than the serviceable failures. An example of ultimate limit state failure is roof blown-off (Blake, 2001).

2.8.2 Serviceability Failure

These are fairly frequent form of structural failures observed in roofs. They appear in form of deflection and cracks on a structural member, or a breakdown of waterproofing cover which could result into water penetrating the roof, in case of concrete, initiating corrosion of reinforcements and in wood structure, causing decay and eventual deterioration. They could lead to disruption of services and interruption of business activities (Blake, 2001).

2.8.3 Special Requirement Failure

This is a functional purpose requirement that has to do with special requirements other than the limit states considered for some special functions other than that of the normal roof functions. For example, in studio design, special precautions are built in the roof to reduce the noise penetration and the acoustics of the roof. The requirement in radiation protection buildings

is to prevent leakage of radio active elements; here the special requirement is to prevent porosity. (Ayoade, 1995).

2.9 Modelling

2.9.1 Definition

A model has been defined by various authors to mean the process of describing a particular system. According to Edwards and Hamson (1992), a model can be defined as a simplified representation of certain aspect of real system while Adeniran (1997) defined model as a set of assumptions, which may take the form of mathematical or logical relationship used to gain an understanding of how a system behaves. Adeniran (1997) went further to stress that if the relationship that compose the model are simple enough, it may be possible to use mathematical methods (such as algebra, calculus or probability theory) to obtain exact information on questions of interest and this is called an analytical solution. For example, the simple equation:

$$P = \frac{F}{A} \quad \text{Eqn. 2. 1}$$

Where P = pressure (N/mm²); F = Force (N) and A = Area in mm², represents a model. If the model is for a hydraulic system that is expected to exact pressure at a point, the modeller will quickly realize that if the area is kept constant, the pressure exacted at the point will increase with force applied. Forrester (1968) disclosed that most real world systems are too complex to allow realistic models to be evaluated analytically, and these models must be studied by means of simulation. Model study can be used to evaluate the influence of various parameters on a system, for example, if the system in question is a roof, some of the parameters influencing roof wind loads include the aerodynamic characteristics of the roof (which are influenced by the shape, size and height above the ground), the degree of local shelter and roughness of the surrounding terrain, the wind speed, orientation of building to the main wind direction and the materials of construction

2.9.2 Classification of Models

Models can be classified into three categories according to their degree of abstraction. These classifications are: Abstract or mental models, Symbolic models (Moderate abstraction) and Exact or Physical Models (Low Abstraction) (Dorfaman, 1970)

(a) Abstract or Mental Models

Abstract models have been described as unclear, ill structured representation of reality that does not have physical or symbolic configuration. This type of model makes use of mental ability. The ability of human being to solve problems is known as mental ability. Mental models have high level of abstraction and involve imagination and creativity. Example of abstract model is imagination of a concept (Dorfaman, 1970).

(b) Symbolic Models

Symbolic models can conveniently be classified into two namely Verbal models and Mathematical models

(i) Verbal Models. Express the resulting features of reality using verbal expressions and can be regarded as the written version of mental models. They promote the classification of the mentally idealized representation. Television adverts of a particular product is an example of verbal models since they try to present a picture of how happily and satisfied you will be if you purchase and use the product being advertised. Another example is journalist report of a mishap, plays and other forms of reports.

(ii) Mathematical Models. They are also symbolic models but instead of words equations are used to express a simplified version of a complex problem. They are approximate representation of a reality. In mathematical model, data can be manipulated by a person in such a way that if another person were to manipulate it, the same unique result would be obtained. Complexities and uncertainties using mathematical model needs to be formulated to describe the existing problem situation (Dorfaman, 1970). With the advent of computers, finding solutions to the complex mathematical models to predict system behaviour using computerized approach results in the advanced mathematical or systemic modeling called computer modeling. Graphical representation in animated form gives computer simulation. This may take the form of writing a programme or using available applications on the computer.

(c) Physical Models

This type of models has physical properties that bear similarity with the real objects. They are either prototypes of the real objects or have characteristics that reflect the function of

the real objects. They are divided into two categories namely Iconic models and Analogue Models

(i) Iconic Models. They look exactly like the real objects but could be scaled downward or upward or could employ change in materials of the real object. They may thus be full sized replicas or scale models like architectural building, model train and model airplane. They could be three dimensional in nature like model cars or two dimensional models like sketches, painting or photographs. The scale iconic models usually aim at communicating design ideas to a client or designer and they represent reality.

(ii) Analogue models are physical models but unlike the iconic models, they may or may not look like the reality of interest. They explain specific few characteristic of an idea and ignore other details in the object. They aim more at performing some basic functions instead of emphasizing and communicating ideas about appearances. Examples are flow diagrams, maps, and circuit diagrams, building plans, organizational plans and other forms of blue prints. (Dorfman, 1970)

2.9.3 Steps in using Mathematical Models to Solve Decision Problem

The steps to take in solving a problem using mathematical modeling techniques are :-
formulating the problem, building the model, analyzing the model, interpreting the model
Validating the model, implementing the model, updating the model (Stanford, 1971)

(a). Formulating the problem involves identifying the aim and objectives of the problems, the various available decision alternatives and the restrictions as well as requirements of the model. This stage reveals the various components that make up the problem.

(b). Building and constructing of the models with all the necessary details built in at the construction stage. The assumptions of the models as well as mathematical framework used to connect the already identified components in the model are well defined. The built model must include objective function, the variables, parameters and the constraints.

(c). Analyzing of the model must be done after the building of the model. At this stage necessary analysis are carried out on the built model using mathematical computations which can be done manually or with computers depending on the complexity of the problem. Solutions can

be obtained either by analytical or numerical techniques. Simulation techniques may be used to solve the model. The sensitivity analysis will reveal how sensitive the solution is with respect to the accuracy of the input data and various assumptions of the model.

(d). The next stage is the validating of the model. This deals with the adequacy and usefulness of the model and the solutions obtained from the model as well as the extent to which the result bears relationship with what happens in the real world. Some of the techniques used for validating a model include historical validating, conceptual validating and expert's validation.

(i) Historical validating is validation in which it is desired to know if, by using historical data, the model can produce observed data.

(ii) Conceptual validating is the validation which seeks to establish how realistic the assumptions of the models are.

(iii) Expert's validation aims at finding out expert opinion about the model.

(e). Implementing the model starts from the commencement of the problem. Here the final results obtained from the study are presented in clear and readable manner with detailed operating instructions for the implementation of the model. Good communication skills and interpersonal relationships are desirable for the effective performance of the model.

(f). The last stage is updating the model. The plans for updating the model should be clearly specified. The model should be used repeatedly in analyzing the decision problem. Revision of the data to take account of both the specifications of the problem and current data is essential.

It is important to note that techniques exist for simplifying complex mathematical problems. This includes elimination of redundant constraints, conversion of discrete variable to continuous variables and vice-versa, converting non-linear functions to linear functions.

Mathematical problems have been used in the past to solve many engineering problems. These included the design of Pneumatic pump, mathematical model for the control of pest and infectious disease diseases, the design of space rocket (Murphy et al, 1990).

CHAPTER THREE

MATERIALS AND METHODS

3.1 Preamble

This research was executed in three phases. These were a survey, experimentation and the development of a mathematical model.

3.2 Survey

3.2.1 Study Location

This study was carried out in Southwestern Nigeria comprising Ekiti, Lagos, Ogun, Ondo, Osun and Oyo states and all categories of buildings were considered in the study. The southwestern Nigeria's climate is characterized by latitudinal zones, becoming progressively drier as one moves north from the coast (Adenekan, 2000). Rainfall is the key climatic variable, and there is a marked alternation of wet and dry seasons in the zone. Two air masses control rainfall and these are the moist northward-moving maritime air coming from the Atlantic Ocean and dry continental air coming south from the land. The region has a bi-modal wind pattern with peaks occurring in April and August with a high wind gust associated with rainstorm causing damage to buildings with the roofs being mostly affected. The beginning of the rains is usually marked by the incidence of high winds and heavy squalls. Minimum temperature in the zone occurs in the month of August due to dense cloud which may be as low as 24.5°C while the highest temperature value of 35°C occurs in the month of February. The study area is shown in Figure 3.1

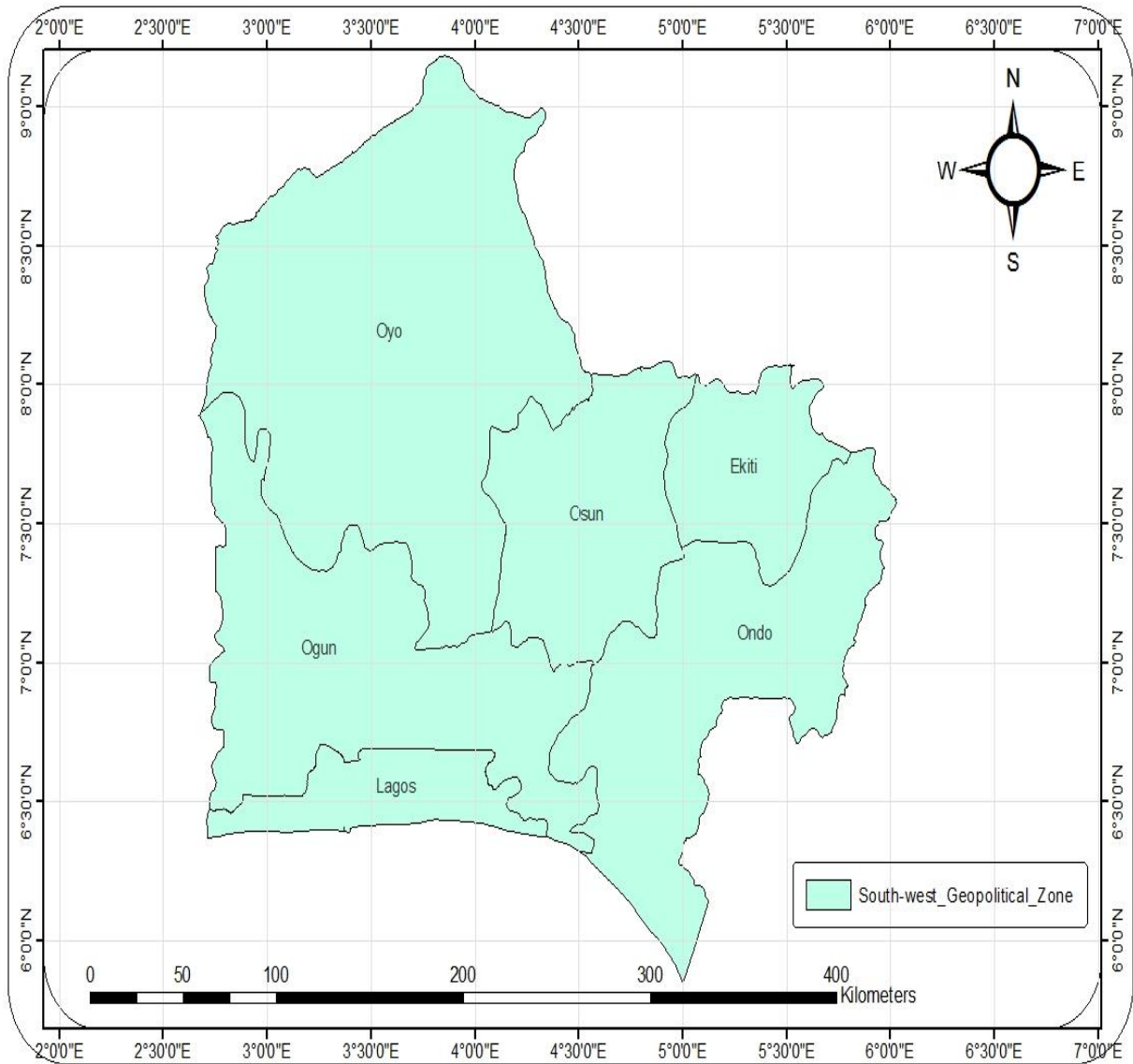

Figure 3.1: Southwestern States

3.2.2 Survey Instruments

The survey was carried out using structured questionnaire, interview schedule; focus group discussion (FGD) and personal observations with photographs recording. Information of interest and which were included in the instruments were the types of roof, materials used in the construction of roof trusses and sheathing, age of roof, maintenance practices, causes of failure and their subsequent consequences(Appendix 1).

The instruments were validated by experts in the building industry and pre-tested at Moniya Ibadan, using respondents who did not form part of the final sample for the study. The pre-testing was very useful as it enabled the instruments to be revised eliminating redundant questions and including vital questions that were previously omitted.

3.2.3 Sample Size

The sample size was determined using the following procedures; one local government from each senatorial district of the state was chosen for study. The selection was based on previous records of the propensity of roof failure from the State Ministry of Environment. The chosen local government area was stratified into four groups. A 25 percent (25%) sample size of the buildings within each town that was chosen were selected by systematic random sampling method. The first house in each town was selected by random sampling while every fifth house was picked systematically. Thirty buildings per location were investigated. Altogether, the roofs of 3,780 buildings were visited and observations made are as contained in Table 3.1

Table 3.1: Distribution of Roofs per State

Location (State)	No. of Buildings	Percentage
Ekiti	450	11.90
Lagos	450	11.90
Ogun	570	15.08
Ondo	360	9.52
Osun	780	20.63
Oyo	1,170	30.96
Total	3,780	100

Source: Field Survey (2009)

3.2.4 Field Work

A reconnaissance survey of the chosen local government area was carried out together with field assistants to acquaint the field assistants with the survey requirements. Thereafter, the local government area was broken into four sub-divisions, two persons to each area to carry out the administration of questionnaires, FGD and interviews.

The survey of roofs was undertaken during the dry season periods of three years to observe structural designs, materials used and their fabrication/erection patterns as well as those other factors that could cause failure. During the raining seasons of these same years, survey was repeated to determine the cases of failure.

Both the failed and the sound roofs were investigated to see if there would be any noticeable differences in the form, design, construction and materials of the failed roofs and those that were still structurally sound, to further evaluate the likely causes of failure in those that failed. During the field work, samples of timbers at point of use, from failed roofs and intact roofs were collected for investigation. During the survey, meteorological data for the study area for a period of five years were obtained from the meteorological station in Ibadan which is the zonal coordinating centre. The data collected were total rainfall (mm); sunshine hours; relative humidity; temperature, wind velocity and prevalent wind direction. These are presented in Appendix 2.

3.3 Experiments

In the cause of this work the following experiments were carried out:

3.3.1 Determination of Moisture Content

The moisture content of wood samples obtained from truss members of both failed and functional roofs and fresh timbers assembled for use in truss construction was determined in accordance with the American Standard for Testing Materials (ASTMD442). This was carried out because wood performance is influenced by the level of moisture content and it was necessary to establish its variation between the point of construction and while in service.. The timber species which are often used in the construction of roof trusses and for which the tests were carried out included Mansonia (*Mansonia altissima*), Ayin (*Anogeissus leiocarpus*), Apa (*Azelia species*), Omoo (*Cordia millenii*), Oroo (*Antiaris Africana*), Teak (*Tectona grandis*)

3.3.2 Corrosion Test on Nails

The strength of a joint depends on the size and the density of nails used in the assembly. As a result of the long-term durability requirements of the roofing system, it was felt that an accelerated exposure testing method was necessary to estimate the long-term corrosion effect on fasteners of joints in wood. Based on this need, a test procedure was adopted in accordance with ASTM 1977 to compare the rate of corrosion, measured by weight loss, of various fastener types under accelerated exposure conditions in wood. Weight loss is considered a measure of lateral bearing strength loss, which is the main requirement of nail wood joint

3.3.3 Determination of the Effects of Temperature Fluctuations

Durability or service life of a roof is to a large degree dependent upon the temperatures it experiences. Knowledge of the thermal response of materials, the variation and extremes of temperature and how to modify or compensate for them is essential for the design of durable roofs. It was therefore decided to determine the effects of temperature fluctuations in the attic of some selected roofs in accordance with the Canadian Building Digest (CBD 36)

3.3.4 Effects of interface gap on Joint Integrity

In this experiment, three interface gaps (6mm, 12mm, and 18mm) were investigated. Altogether, 192 joint tests were performed. The ends of the specimens were cut perpendicular to the longitudinal axis. Lead holes were drilled at proper locations and the joint members were carefully nailed together with a common wire nail of 75mm length (3mm diameter). The specimens were fabricated about an hour prior to their testing. To achieve joints with an interface gap, a cardboard paper of thickness corresponding to the required interface gap was inserted between the joint members and then these members were nailed together. The cardboard was removed from the joint specimen just before the commencement of the testing. Care was taken to maintain the interface gap at the time the cardboard paper was being pulled out.

The joint specimens were tested on an Instron universal testing machine at a rate of loading of 0.5N per minute. Figure 3.2 shows a schematic representation of a joint specimen under loading.

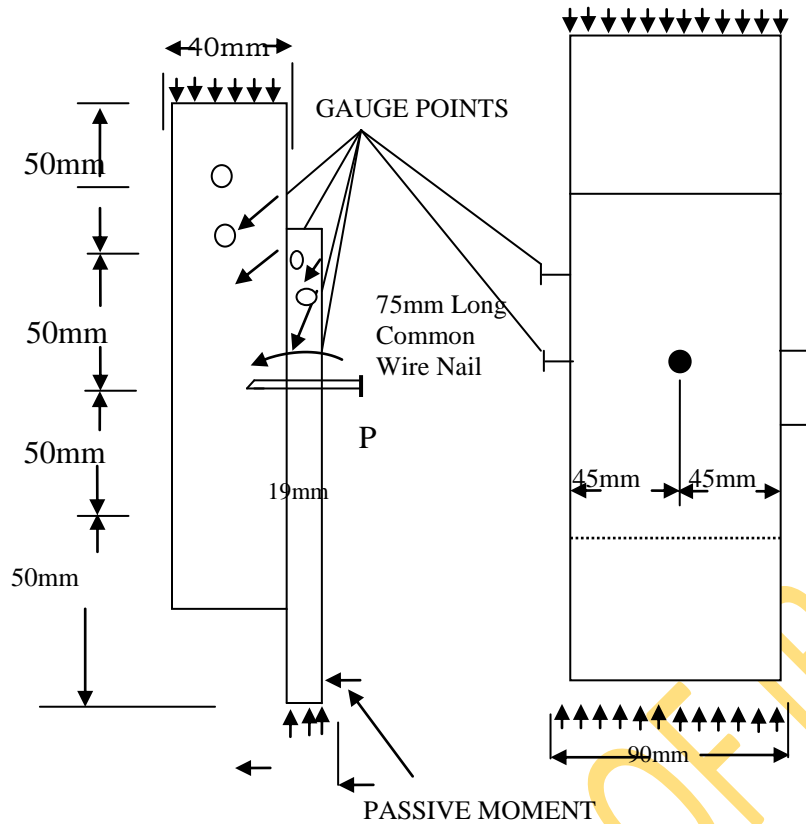

Figure 3.2: Details of nailed joint subjected to

3.4.0 Development of Roof Blown-off Model

Data obtained from the survey and experimentations were evaluated and interpreted using statistical correlation and graphical presentation. These data were then incorporated to the model formulation and with the aid of FOTRAN software package; a programme was written that made predictions of roof blown-off possible.

The model was developed in modules:

- a. Design speed module
- b. Angle of attack module
- c. Topographical location module
- d. Roof Geometry module.

Design wind speed for the zone was modeled using Cook-Mayne (CM) method (Cook and Mayne, 1979) which adopted the Monte Carlo techniques reported by Ulam and Metropolis, (1949). These resulted in few working graphs and tables from where the maximum design speed,

for different structure's life-time and at different margins of risk could be obtained. In modeling wind speed uphill, Peronian (1962) and general fluid flow (Anonymous, 1953) equations were analytically combined taking venturi effect of hills into consideration. Gable and Hip roofs resistance to overturning moments were investigated for different wind speeds and topographical locations.

3.4.1 Algorithm for Determining the Blow-off Model

Assumptions

- The overturning moment due to wind pressure shall not exceed 75% of the moment of stability disregarding live loads.
- Roof structure is extremely stiff hence method of analysis is quasi-static
- Roof is under steady (time-invariant) wind load
- $F = f(L, H, \alpha, g, \rho, v, \mu, \partial\rho/\partial p, n)$ Eqn. 3.1

Where:

F is the force on the roof (N/ mm²)

L is the length of the building (identical cross sectional shape) (m)

g is the acceleration due to gravity (m/s²)

ρ is the density of air (kg/m³)

v is the mean wind speed (m/s)

μ is the coefficient of viscosity of the wind(m²/s)

α is the orientation of the building to the wind (degrees)

The process of solving the mathematical problem of blow-off (algorithm) is described in Figure 3.3.

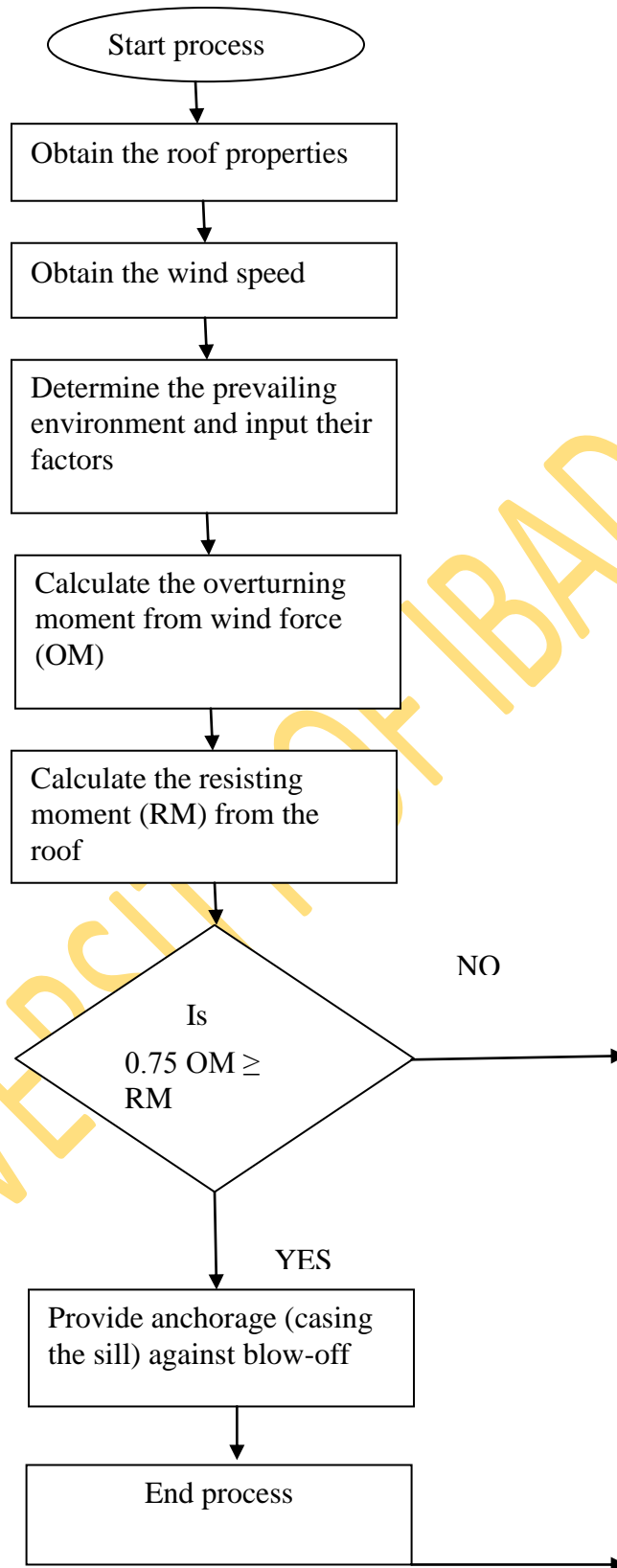

Figure 3.3 Algorithm for the Roof Blow-off Model

3.5.0 Model Validation

Using FORTRAN programming to obtain the overturning and resisting moments, the mathematical model was validated with captured data from survey and existing literatures. During validation another set of locations different from those that were used for modeling were used to validate the model.

3.6.0 Development of the Model

The theory developed by Paulhus *et al*, (1958) for roof failure under adverse condition is extended in this research to study the effect of topography, wind direction, roof materials and roof geometry on roof blown off. This theory is based on the assumption of aerodynamic characteristics of roof, the veering characteristics of wind and the environmental conditions of the zone.

The causal factor of roof blow-off is wind, most of the roof failures that occur do not take into consideration the effect of wind speed gusting uphill. As the flow pattern is dependent upon a steady flow wind speed, it would be reasonable to use the maximum wind speed forecast for a return period that will equal the lifetime of the building.

3.6.1 Building Topographical Location

On mountain ridges and summits, wind speeds are higher than in the free air at corresponding elevations because of the convergence of the air forced by the orographic barriers (Paulhus *et al*. 1958). In trying to predict the effect of hill slope on wind speed, the Peronian equation was adopted and considering venturi as a result of the hill the relationship between wind speeds at the summit compared to the plain was obtained.

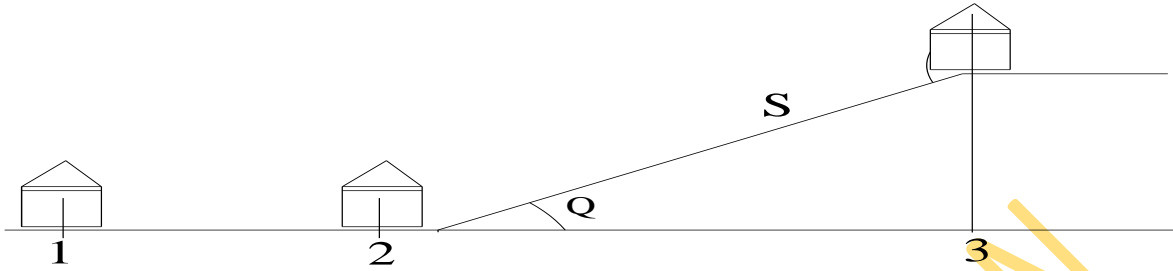

Fig 3.4: Building Topographical Location

The volume of fluid flow is related to the pressure in the fluid according to general fluid flow while Peronain also related the flow in gas with height above ground. These two principles were adapted to model wind flow over hills. The wind was idealized as fluid flowing in an imaginary pipe of infinite diameter.

$$Q = A_3 E \sqrt{\frac{2gp}{w}} \quad \text{Eqn. 3.2}$$

$$E^2 = \frac{A_2^2 - A_3^2}{A_2^2} \quad \text{(General fluid equation)} \quad \text{Eqn. 3.3}$$

$$\frac{Q}{A_3 E} = \sqrt{\frac{2gp}{w}} \quad \text{Eqn. 3.4}$$

$$\text{Let } n = \frac{A_3}{A_2} \quad \text{Eqn. 3.5}$$

$$E = (1 - n^2)^{0.5} \quad \text{Eqn. 3.6}$$

$$\frac{A_3^2 V_3^2 \left(\frac{A_2^2 - A_3^2}{A_2^2} \right)^{-1}}{A_3} = \frac{2pg}{w} \quad \text{Eqn. 3.7}$$

$$\frac{V_3^2 A_2^2 \left(\frac{w}{2g} \right)}{A_2^2 - A_3^2} = p \quad \text{Eqn. 3.8}$$

$$\text{According to Peronian, } p = 0.5wkv^2 \quad \text{Eqn. 3.9}$$

Where W = density of air, in kg/m³

Q = Quantity of flow, in m³

A₂ = Area at location 2, in m²

A₃ = Area at location 3, in m²

K = gust factor

V = Wind speed, in m/s

P_h is pressure at height h, in N/m²

p + dp is pressure at height h+dh, in N/m²

$$p_h = 0.5wkv^2 \left(\frac{h}{10} \right)^{\frac{2}{7}} \quad \text{Eqn. 3.10}$$

$$p_{h+dh} = 0.5wkv^2 \left(\frac{h+dh}{10} \right)^{\frac{2}{7}} \quad \text{Eqn. 3.11}$$

$$dp = 0.5wkv^2 \left[(h+dh)^{\frac{2}{7}} - h^{\frac{2}{7}} \right] \times 10^{\frac{2}{7}} \quad \text{Eqn. 3.12}$$

$$= 0.259wkv^2 (h+dh)^{\frac{1}{7}} - h^{\frac{1}{7}} dh \quad \text{Eqn. 3.13}$$

$$p = 0.259wkv^2 \int (h+dh)^{\frac{1}{7}} - h^{\frac{1}{7}} d\phi \quad \text{Eqn. 3.14}$$

$$\text{Let } h = l \sin \phi \text{ and } dh = l \cos \phi \quad \text{Eqn. 3.15}$$

$$p = 0.259wkv^2 l^{\frac{1}{7}} \int (\sin \phi + \cos \phi)^{\frac{1}{7}} - \sin \phi^{\frac{1}{7}} d\phi \quad \text{Eqn. 3.16}$$

$$\frac{V_3^2 A_2^2 w}{(A_2^2 - A_3^2) 2g} = 0.259wkv^2 l^{\frac{1}{7}} \int (\sin \phi + \cos \phi)^{\frac{1}{7}} - \sin \phi^{\frac{1}{7}} d\phi \quad \text{Eqn. 3.17}$$

$$V_3^2 = \frac{(A_2^2 - A_3^2)}{A_2^2} \times 5.08kv^2 l^{\frac{1}{7}} \int (\sin \phi + \cos \phi)^{\frac{1}{7}} - \sin \phi^{\frac{1}{7}} d\phi \quad \text{Eqn. 3.18}$$

$$\text{Let } A_2 = h + y \quad \text{Eqn. 3.19}$$

$$\text{And } A_3 = y \quad \text{Eqn. 3.20}$$

Taking 1 as unity, and considering pressure at “y” above ground.

$$V_3^2 = \frac{h(2+y)}{(h+y)^2} \times 5.08kv^2 \int (\sin \phi + \cos \phi)^{\frac{1}{7}} - \sin \phi^{\frac{1}{7}} d\phi \quad \text{Eqn. 3.21}$$

$$= \frac{5.08kh(h+2y)}{(h+y)^2} \times v^2 \int (\sin \phi + \cos \phi)^{\frac{1}{\alpha}} - \sin \phi^{\frac{1}{\alpha}} d\phi \quad \text{Eqn. 3.22}$$

$$\text{Let } \sin \phi + \cos \phi = x \quad \text{Eqn. 3.23}$$

$$\int (\sin \phi + \cos \phi)^{\frac{1}{\alpha}} = \int x^{\frac{1}{\alpha}} d\phi = \int x^{\frac{1}{\alpha}} d\phi \frac{dx}{dx} \quad \text{Eqn. 3.24}$$

$$= \frac{\int x^{\frac{1}{\alpha}} dx}{(\cos \phi - \sin \phi)} \quad \text{Eqn. 3.25}$$

$$= \frac{\alpha y^{\frac{(1+\alpha)}{\alpha}}}{(1+\alpha)} \quad \text{Eqn. 3.26}$$

$$= \frac{\alpha}{(1-\alpha)} \frac{(\sin \phi - \cos \phi)^{\frac{9}{7}}}{(\cos \phi - \sin \phi)} \quad \text{Eqn. 3.27}$$

$$\text{Let } Z = \sin \phi \text{ and } dZ = \cos \phi \quad \text{Eqn. 3.28}$$

$$\int (\sin \phi)^{\frac{1}{\alpha}} d\phi = \int Z^{\frac{1}{\alpha}} d\phi = \int Z \left(\frac{d\phi}{dZ} \right) dZ \quad \text{Eqn. 3.29}$$

$$\int Z^{\frac{1}{\alpha}} d\phi = \int Z^{\frac{1}{\alpha}} d\phi \frac{dZ}{dZ} = \frac{\int Z^{\frac{1}{\alpha}} dZ}{(\cos \phi - \sin \phi)} \quad \text{Eqn. 3.30}$$

$$= \frac{\alpha}{(1+\alpha)} Z^{\frac{(1+\alpha)}{\alpha}} \quad \text{Eqn. 3.31}$$

$$= \frac{\alpha}{(1+\alpha)} \left(\frac{(\sin \phi - \cos \phi)^{\frac{9}{7}}}{(\cos \phi - \sin \phi)} \right) \quad \text{Eqn. 3.32}$$

$$V_s^2 = 0.9984 \frac{h(h+2y)}{(h+y)^2} \left(\frac{(\sin \phi + \cos \phi)^{\frac{9}{7}}}{(\cos \phi + \sin \phi)} - \frac{(\sin \phi)^{\frac{9}{7}}}{\cos \phi} \right) \quad \text{Eqn. 3.33}$$

When $\phi = 0$ at the plane $V_s = V$

V_s is the speed along the slope, in m/s

Y is the height above the ground, in m

V is the speed at the bottom of the hill, m/s

Φ is the slope angle, in degree

H is the height of hill at the referenced point, in m

It has been discovered that the distance of shelterbelt is related to the angle of deviation of the prevailing wind from perpendicular.

Using the shelterbelt equation of $d = 17h \cos \theta \left(\frac{v_m}{v} \right)$ Eqn. 3.34

d is the distance of full protection (m)

h is the height of shelterbelt (m)

v_m is the minimum wind speed at height 15.2m above ground (m/s)

v is the actual wind speed at velocity 15.2m above ground (m/s)

θ is the angle of deviation of the prevailing wind direction from the perpendicular (degree).

Based on the relationship developed for wind flow uphill, the distance of full shelter protection for hills or various slope are calculated in Table 3.2

Table 3.2: Relationship of full protection with slope of Hill

Slope of hill (Degree)	Distance of full protection of a 3m shelter belt (m)	Full protection as percentage of full protection at the plain (%)
0	45.3	100
5	39.97	88
10	37.66	83
15	34.69	77
20	31.43	69
25	27.75	61
30	23.67	52
35	18.96	42
40	12.97	29

3.6.2 Roof geometry

It is desired to investigate the effect of geometry on total roof failure while other parameters were kept constant and hip roofs and gable roofs were investigated for stability

against wind overturning. This roof geometry factor is considered to know how the size and shape of the roof affect roof failure.

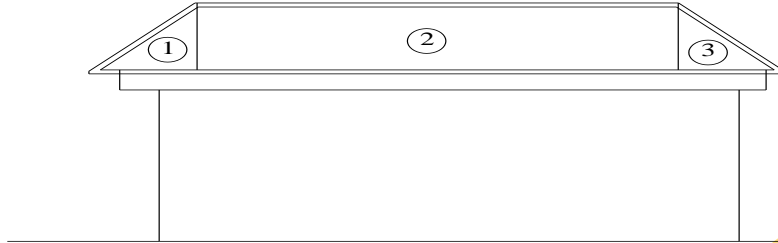

Fig 3.5: Side Elevation View of Hip Roof

It is believed that the stability of a roof is dependent on the location of the centre of pressure of the roof hence the section below set out to calculate the position of the centre of pressure of the two common shapes in the zone. Table 3.3 shows how to calculate the center of pressure of roofs of various shapes

Table 3.3: Calculation of the Roof Centre of Pressure

Section	Area (A)	\bar{X}^1	$A\bar{X}^1$
1	$\frac{(\alpha_1 L)^2 \tan \delta}{2}$	$\frac{2\alpha_1 L}{3}$	$\frac{(\alpha_1 L)^3 \tan \delta}{6}$
2	$\frac{RL^2 \tan \theta (1 - \alpha_1 - \alpha_2)}{2}$	$(1 + \alpha_1 - \alpha_2)L$	$\frac{Rl^3}{4} \tan \theta (1 - 2\alpha_2 + \alpha_2^2 \alpha_1)$
3	$\frac{\alpha_2 l^2 \tan D}{2}$	$\frac{(3 - 2\alpha_2)L}{3}$	$\frac{\alpha_2^2 L^3}{6} \tan D (3 - 2\alpha_2)$

$$\sum A = \alpha_1 l^2 \tan \delta + \alpha_2^2 \left(\tan D + \frac{Rl^2}{2} \tan \theta \left(\frac{1 - \alpha_1 - \alpha_2}{2} \right) \right) \quad \text{Eqn. 3.35}$$

$$= \left[\alpha_1^2 \tan \delta + \alpha_2^2 \tan D + R \tan \theta (1 - \alpha_1 - \alpha_2) \right] \frac{l^2}{2} \quad \text{Eqn. 3.36}$$

$$= \frac{[l - \alpha_1 - \alpha_2 + 2\alpha_1 l + 2\alpha_2 l] R l \tan \theta}{2} \quad \text{Eqn.3.37}$$

$$\text{Since } \frac{\alpha_1 \tan \delta}{3} = \frac{\alpha_2^2 \tan D}{3} = \frac{R l \tan \theta}{6} \quad \text{Eqn. 3.38}$$

$$\sum AY^1 = \frac{(\alpha_2 l)(R l \tan \theta)^2}{6} + \frac{(\alpha_1 l)(R l \tan \theta)^2}{6} + \frac{(R l \tan \theta)^2 x (l - \alpha_2 - \alpha_1)}{4} \quad \text{Eqn. 3.39}$$

$$= \frac{(3l - 3\alpha_1 - 3\alpha_2 + 2\alpha_1 l + 2\alpha_2 l)(R l \tan \theta)^2}{12} \quad \text{Eqn. 3.40}$$

$$\frac{\sum AY^1}{\sum A} = \frac{l \left[(3 + 2\alpha_1 + 2\alpha_2) - 3\alpha_1 - 3\alpha_2 \right] (R l \tan \theta)^2}{12 (R l \tan \theta (l - \alpha_1 - \alpha_2 + 2\alpha_1 l + 2\alpha_2 l))} \quad \text{Eqn.3.41}$$

$$Y^1 = \frac{l \left[(3 + 2\alpha_1 + 2\alpha_2) - 3\alpha_1 - 3\alpha_2 \right] (R l \tan \theta)^2}{6 R l \tan \theta (l - \alpha_1 - \alpha_2 + 2\alpha_1 l + 2\alpha_2 l)} \quad \text{for hip roof} \quad \text{Eqn.3.42}$$

If $\alpha_1 = \alpha_2 = 0$, i.e a gable roof, then

$$Y^1 = \frac{l R \tan \theta}{2} \quad \text{Eqn.3.43}$$

From the above equation, the centre of pressure in hip roof is lower than in gable roof indicating less overturning moment in hip roof than in gable roof.

α_1 = ratio of the length of the point of bevel of the roof in side one

α_2 = ratio of the length of the point of bevel of the roof in side two

D = angle of slope at bevel point α_1 (degree)

θ = roof main slope (degree)

δ = angle of slope at bevel point α_2 (degree)

R = B/L

B = Breadth of the building

L = Length of the building

Covering Material

The weight and subsequently the resistance of roof to overturning from wind force depend largely on the quantity of the covering materials. Therefore it is necessary to know the area of the covering materials.

The area of the covering materials for hip roof is derived as follows:

$$= (\alpha_1 l \cos \delta)B + (\alpha_2 l \cos D)B + 2(l - \alpha_1 - \alpha_2) \frac{B}{2} \cos \frac{\theta}{2} \quad \text{Eqn. 3.44}$$

$$= BL(\alpha_1 \cos \delta + \alpha_2 \cos D + \cos \theta) - \alpha_1 B \cos \theta - \alpha_2 B \cos \theta \quad \text{Eqn. 3.45}$$

$$= B(L(\alpha_1 \cos \delta + \alpha_2 \cos D) + \cos \theta(l - \alpha_1 - \alpha_2)) \quad \text{Eqn. 3.46}$$

α_1 = ratio of the length of the point of bevel of the roof in side one

α_2 = ratio of the length of the point of bevel of the roof in side two.

D = angle of slope at bevel point α_2 (degree)

δ = angle of slope at bevel point α_1 (degree)

θ = slope of the roof. (Degree)

If $\alpha_1 = \alpha_2 = 0$ indicating gable, the sheathing area is given by

$$A = BL \cos \theta \quad \text{Eqn. 3.47}$$

Hence covering materials in hip roof is greater than that of gable roof with invariably greater resistance.

3.6.3 Roof Orientation

Allowance was made for wind forces on the roof assuming the wind from any possible direction to be critical. Thus, in the model the wind was to be considered normal to the plane surface of the roof. The orientation factor is considered crucial as it has been found out that when

a building is at angle 45° to the incidence wind, the average indoor air velocity is increased (Koenigsberger et al, 1974)

In modeling the angle of attack module, the roof has been positioned in such away that the building is having its breadth across the wind direction as shown in figure 3.6. The ratio of the increase in contact area due to certain degree of orientation compared to that at 0° orientation is related by the equation

$$C_a = \frac{Z \sin \theta + B \cos \theta}{B} \quad \text{Eqn. 3.48}$$

To obtain the angle at which the orientation to the main wind direction will be critical, Eqn. 3.48 is differentiated with respect to θ .

$$\text{At the critical angle, } \frac{dC_a}{d\theta} = 0 \quad \text{Eqn. 3.49}$$

$$\text{Hence } \frac{Z \cos \theta}{B} = \sin \theta \quad \text{Eqn. 3.50}$$

Therefore the maximum area of attack is at the critical angle, θ , obtained as

$$\theta = \text{Tan}^{-1}\left(\frac{Z}{B}\right) \quad \text{Eqn. 3.51}$$

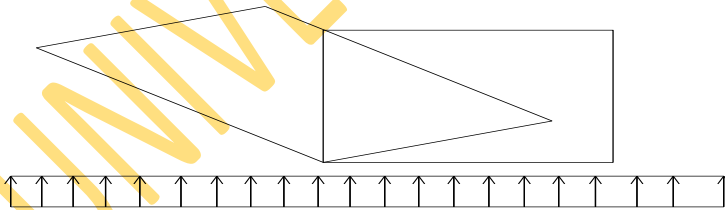

Fig 3.6: Projected Area of Wind Attack

3.6.4 Comparison of Area of Roof under Attack

Having obtained the areas of the covering materials for both types of roof, it is very important that the total areas of exposures of the each type of roof under wind load be obtained. This is shown in Figure 3.7 and Figure 3.8 for hip and gable respectively

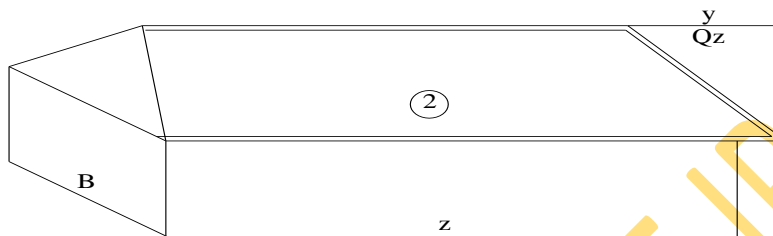

Fig 3.7: Hip Roof

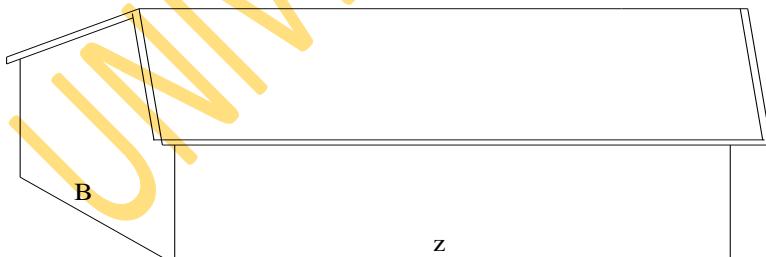

Fig 3.8: Gable Roof

Figures 3.7 and 3.8 represent two different roofs of the same building dimension but different roof shape. When the two types of roof are exposed to wind action the effective areas of attack is as found below. The calculations are shown in Table 3.4

Table 3.4: Calculation of the Areas of Hip and Gable Roofs

Hip Roof	Gable Roof
$A_H = b \left(\frac{kb - y}{\cos \theta} \right) + \frac{y}{\cos \alpha}$ $= \frac{b((kb - y)\cos \alpha + y \cos \theta)}{\cos \theta \cos \alpha}$	$A_G = \frac{b(kb) \times 2}{2 \cos \theta} = \frac{kb^2}{\cos \theta}$

The ratio between the two areas is calculated as follows:

$$\frac{A_H}{A_G} = \frac{b((kb - y)\cos \alpha + y \cos \theta)}{\cos \theta \cos \alpha} \times \frac{\cos \theta}{kb^2} \quad \text{Eqn. 3.52}$$

$$= \frac{b((kb - y)\cos \alpha + y \cos \theta)}{kb^2 \cos \alpha} \quad \text{Eqn. 3.53}$$

If $y = 0$ and $\theta = 0$, then the shape is gable and $A_H = A_G$ the entire area is exposed to the wind

$$\frac{A_H}{A_G} = \frac{A_G}{A_G} = 1 \quad \text{Eqn.3.54a}$$

When $y \neq 0$ and $\theta \neq 0$ the ratio is not unity but is obtained from the equation below

$$\frac{A_H}{A_G} = 1 - \frac{y(\cos \alpha - \cos \theta)}{kb \cos \alpha} \quad \text{Eqn. 3.54b}$$

From the above analysis the area exposed under hip roof to wind attack is less than that of gable roof.

Where $Z = kb$

y = the length of trimmed end (metres)

θ = the roof main angle (degree)

α = angle of the trimming (degree)

A_C = Area under wind load (m^2)

3.6.5 Calculation of the hip length of hip roof

The length of hip in a hip roof is a function of the main roof slope, hip angle and the breadth of the building on top of which the roof is located. The longer the hip length the more materials are consumed hence the need to calculate the hip length.



Plate 3.9: Hip length

$$\frac{b^2 + 4y^2 + b^2 \tan \theta}{4} = T^2 \quad \text{Eqn. 3.55}$$

$$\frac{b^2 + 4y^2 + b^2 \tan \theta}{4} = T^2 \quad \text{Eqn. 3.56}$$

$$\text{but } \sin \alpha = \frac{b}{2T} \quad \text{Eqn. 3.57}$$

$$T = \frac{b}{2 \sin \alpha} \quad \text{Eqn. 3.58}$$

$$\frac{b^2 + 4y^2 + b^2 \tan^2 \theta}{4} = \frac{b^2}{4 \sin^2 \alpha} \quad \text{Eqn. 3.59}$$

$$\frac{b^2 + 4y^2 + b^2 \tan^2 \theta}{b^2} = \frac{1}{\sin^2 \alpha} \quad \text{Eqn. 3.60}$$

$$\sin^2 \alpha (1 + \tan^2 \theta) + \frac{4y^2 \sin^2 \alpha}{b^2} = 1 \quad \text{Eqn. 3.61}$$

$$\sin^2 \alpha (1 + \tan^2 \theta) = \frac{b^2 - 4y^2 \sin^2 \alpha}{b^2} \quad \text{Eqn. 3.62}$$

$$b^2 \sin^2 \alpha (1 + \tan^2 \theta) - b^2 = -4y^2 \sin^2 \alpha \quad \text{Eqn. 3.63}$$

$$4y^2 \sin^2 \alpha = b^2 - b^2 \sin^2 \alpha (1 + \tan^2 \theta) \quad \text{Eqn. 3.64}$$

$$y^2 = \frac{b^2}{4} \left(\frac{1}{\sin^2 \alpha} - (1 + \tan^2 \theta) \right) \quad \text{Eqn. 3.65}$$

$$y = \frac{b}{2} \left(\frac{1}{\sin^2 \alpha} - (1 + \tan^2 \theta) \right)^{0.5} \quad \text{Eqn. 3.66}$$

3.7.0 Optimization of Pitch Angle

The weight of roofing materials is important from several perspectives. First, the heavier the material, the higher the resisting moment against uplift therefore a good roof truss must be able to withstand its own weight and the anticipated live load. To obtain the optimal pitch angle of a truss for a particular pitched roof, a frame of least weight that would support the anticipated live load must be analyzed as follows.

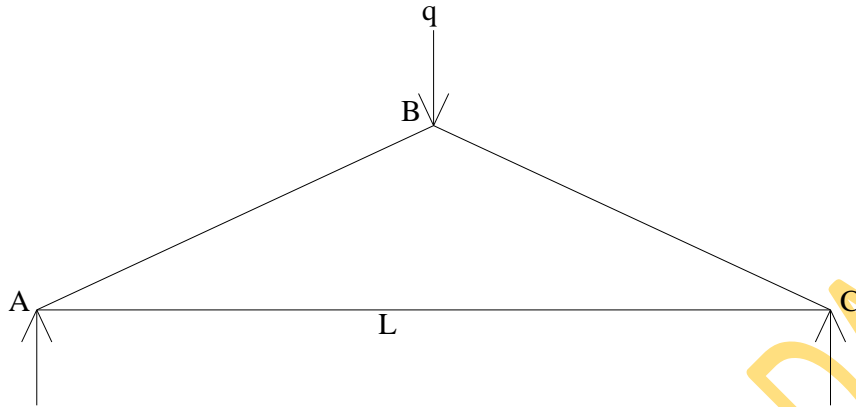

Fig 3.9: Load on Truss

$$\text{Let } W = \rho \left(A_{AC} L + 2A_{AB} * \frac{L}{2 \cos \theta} \right) \quad \text{Eqn. 3.67}$$

Where A_{AC} , A_{AB} are the cross sectional areas for the indicated members and ρ is the density of the truss material.

If b is the permissible stress, then

$$\frac{F_{AB}}{A_{AB}} = \frac{F_{AC}}{A_{AC}} \quad \text{Eqn. 3.68}$$

$$\text{But } F_{AB} = F_{BC} = \frac{q}{\sin \theta} \quad \text{and } F_{AC} = \frac{q \cos \theta}{2 \sin \theta} \quad \text{Eqn. 3.69}$$

$$\text{Hence } A_{AB} = \frac{q}{2b \sin \theta} \quad \text{and } A_{AC} = \frac{q \cos \theta}{2b \sin \theta} \quad \text{Eqn. 3.70}$$

$$\therefore W = \rho \left(\left(\frac{qL \cos \theta}{2b \sin \theta} \right) + \frac{qL}{b \sin 2\theta} \right) \quad \text{Eqn. 3.71}$$

$$qL\rho \left(\frac{1 + \cos^2 \theta}{b \sin 2\theta} \right) \quad \text{Eqn. 3.72}$$

$$\frac{dW}{db} = 0 \quad \text{for minimum weight} \quad \text{Eqn. 3.73}$$

$$\frac{-\left(2 \sin \theta \cos \theta \sin 2\theta + 2 \cos 2\theta \cos^2 \theta - 2 \cos 2\theta\right)}{\sin^2 2\theta} = 0 \quad \text{Eqn. 3.74}$$

$$-2 \sin \theta \cos \theta (2 \sin \theta \cos \theta) - \left(2 \cos^2 - 1\right) (2 \cos^2 \theta + 2) = 0 \quad \text{Eqn. 3.75}$$

$$-4 \sin^2 \theta \cos^2 \theta - \cos^4 \theta - 4 \cos^2 \theta + 2 \cos^2 \theta + 2 = 0 \quad \text{Eqn. 3.76}$$

$$\left(-1 + \cos^2 \theta\right) (4 \cos^2 \theta) - 4 \cos^4 \theta - 4 \cos^2 \theta + 2 \cos^2 \theta + 2 = 0 \quad \text{Eqn. 3.77}$$

$$-4 \cos^2 \theta + 4 \cos^4 \theta - 4 \cos^4 \theta - 4 \cos^2 \theta + 2 \cos^2 \theta + 2 = 0 \quad \text{Eqn. 3.78}$$

$$-6 \cos^2 \theta + 2 = 0 \quad \text{Eqn. 3.79}$$

$$\cos \cos^2 \theta = \frac{1}{3} \quad \text{Eqn. 3.80}$$

$$\therefore \cos \theta = \pm 0.577350269, \text{ and } \theta = 54.75 \text{ or } 125.25$$

3.8.0 Courtyard Effect on Wind Flow

The courtyard effect of wind flow over a roof was investigated using a model of a spherical hole with radius 'a' that is suddenly formed in an incompressible fluid. The time taken for a hole to be filled with fluid was calculated to determine the time flow past the roof. (Choiniere, 2006)

The flow after the formation of the hole, the flow will be spherically symmetrical, the velocity at every point being directed to the centre of the hole. For the radial velocity $v_r = v < 0$ we have Euler's equation in spherical coordinates:

$$\frac{dv}{dt} + \frac{v dv}{dr} = \frac{1}{\rho} \frac{dp}{dr} \quad \text{Eqn. 3.81}$$

The equation of continuity gives

$$r^2 v = F(t) \quad \text{Eqn. 3.82}$$

Where $F(t)$ is an arbitrary function of time; this equation expresses the fact that, since the fluid is incompressible, the volume flowing through any spherical surface is independent of the radius of that surface.

Substituting for v from (Eqn.3.82) in (Eqn. 3.81), the following is obtained,

$$\frac{F(t)}{r^2} + \frac{v dv}{dr} = \frac{-1}{\rho} x \frac{dp}{dr} \quad \text{Eqn. 3.83}$$

Integrating this equation over r from the instantaneous radius $R = R(t) \leq a$ of the hole to infinity we obtain

$$\frac{F'(t)}{R} + 0.5v^2 = \frac{p_0}{\rho} \quad \text{Eqn. 3.84}$$

Where $V = \frac{\partial R(t)}{\partial t}$ is the rate of change of the radius of the hole, and P_0 is the pressure at infinity; the fluid velocity at infinity is zero, and so is the pressure at the surface of the hole we find.

$$F(t) = R^2(t)V(t) \quad \text{Eqn. 3.85}$$

And, substituting this expression for $F(t)$ in (3.83), we obtain the equation

$$\frac{-3v^2}{2} = 0.5R \frac{\partial v^2}{\partial R} = \frac{p_0}{\rho} \quad \text{Eqn. 3.86}$$

The variables are separable; integrating with the boundary condition $V = 0$ for $R = a$ (the fluid being initially at rest), we have.

$$V = \frac{\partial R}{\partial t} = \frac{-2p_0}{3\rho \left(\left(\frac{a}{3} \right)^3 - 1 \right)^{0.5}} \quad \text{Eqn. 3.87}$$

Hence we have for the required total time for the hole to be filled

$$T = \frac{3\rho}{2p_0} \int \frac{dr}{\left(\left(\frac{a}{r} \right)^3 - 1 \right)^{0.5}} \quad \text{Eqn. 3.88}$$

This integral reduces to a beta function, and we have finally

$$T = \left(\frac{3a^2 \rho}{\pi} \right)^{0.5} \frac{5}{4p_0} \quad \text{Eqn. 3.89}$$

$$= 0.915a \left(\frac{\rho}{\rho_0} \right)^{0.5} \quad \text{Eqn. 3.90}$$

From the above it will take some time for air to fill in the courtyard and this will therefore reduce the drag effect of the wind on the roof structure. As wind flows over the roof, it leads to uplift, the faster the wind the greater is the uplift, therefore when courtyard slows down the speed of passage over the roof it reduces the tendency for uplift.

3.9 Determination of Maximum Design Wind Speed using Cook-Mayne Method

This method approaches both the wind speed and pressure coefficient from an extreme value point of view. Cook – Mayne method noted that the probability density function of V follows a Weibull distribution so that the extreme value of V follows a Fisher Tippet type 1 distribution. Thus

$$P(v) = \exp(-\exp(-y_v)) \quad \text{Eqn. 3.91}$$

It is generally accepted that the wind force (F) can be related to the maximum wind speed (V) by a relation of the form:

$$F = CV^2 \quad \text{Eqn. 3.92}$$

Where C is a coefficient of proportionality called the shape factor

The structure's lifetime (T) can also be related to the probability (P) that the maximum velocity will not exceed the extreme value V_{\max} , by the relation,

$$T = (1 - p)^{-1} \quad \text{Eqn. 3.93}$$

For example if the required lifetime is 50 years, a maximum annual velocity V_{\max} which has not occurred for 98% of the annual records is stipulated. Sometimes the recording time may be too short for the required probability. In such cases extrapolation is possible if the available readings can be reduced to a certain graph. This method of extrapolation can be clarified by taking Abeokuta's record as an example. In this technique the maximum annual velocities (V_{\max}), after being checked for homogeneity and consistency, are plotted against the reduced variate (V), as shown in Fig.3.11

Table 3.4 shows Abeokuta's annual maximum gust speeds between 2002 and 2006, arranged in an ascending order (Col. 2) with a corresponding rank r as shown in column 3, the probability of their non-recurrence, P (Col. 4), is calculated from the relation:

$$P = \frac{r}{N+1} \quad \text{Eqn. 3.94}$$

Where: N, is the number of observations. Finally Column 5 indicates the reduced variate, Y, calculated from:

$$Y = -\ln(-\ln P) \quad \text{Eqn. 3.95}$$

The required extreme value, V_{\max} , is hence obtained from the linear relation, resulting from the best straight line through the field points which can be expressed as:

$$V_{\max} = AY + B \quad \text{Eqn. 3.96}$$

Where A, B are constants unique to the site. Numerical values for these constants can be found from the relations:

$$A = \frac{\sigma}{\sigma_N} \quad \text{and} \quad B = V_{\text{mean}} - AY_N \quad \text{Eqn. 3.97}$$

Where σ_N and Y_n are correction factors for a particular sample size, and σ is the standard deviation. For a sample size of 40 (as for Abeokuta), Gumbel (1958) suggests the following values;

$$\sigma_N = 1.14132; \quad Y_n = 0.54362$$

Calculating σ as 21.55km/hr, the best straight line for Abeokuta can be obtained as:

$$V_{\max} = 58.81 + 18.9Y \dots \dots \dots \text{Eqn. 3.98}$$

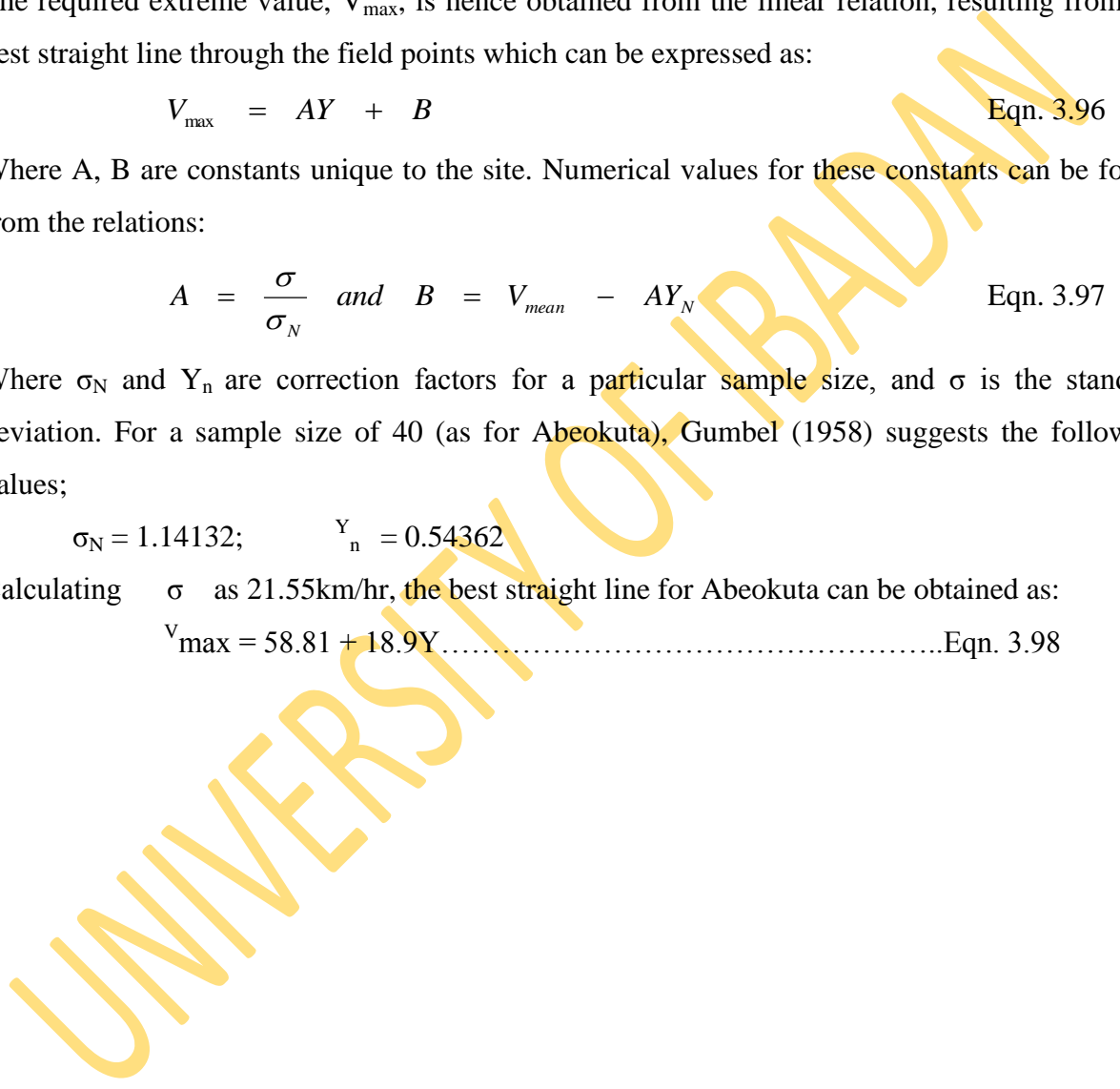

Table: 3.5. Maximum Annual Wind Speed at Abeokuta

Month (1)	Max. Gust (Km/hr) (2)	Rank R (3)	Frequency F (4)	Reduced Variate y (5)
28.02. 2006	39.07	1	0.024	-1.32
28.02. 2005	39.41	2	0.048	-1.11
31.07. 2006	40.97	3	0.073	-0.96
28.02. 2003	41.66	4	0.098	-0.84
30.06. 2003	43.32	5	0.122	-0.74
31.05. 2002	43.99	6	0.146	-0.65
30.04. 2003	44.15	7	0.171	-0.57
31.03. 2004	47.37	8	0.195	-0.49
31.03. 2005	49.38	9	0.220	-0.41
31.10. 2003	49.93	10	0.244	-0.34
31.10. 2004	51.63	11	0.268	-0.28
30.09. 2002	53.60	12	0.293	-0.21
30.11. 2004	56.99	13	0.317	-0.14
31.07. 2003	58.98	14	0.341	-0.07
31.03. 2006	60.78	15	0.366	-0.01
30.06. 2002	61.71	16	0.390	0.06
30.04. 2002	61.88	17	0.415	0.13
30.09. 2003	62.00	18	0.439	0.19
31.01. 2003	64.61	19	0.463	0.26
31.01. 2006	67.17	20	0.488	0.33
31.12. 2004	67.30	21	0.512	0.40
28.02. 2002	67.95	22	0.537	0.48
31.10. 2006	69.00	23	0.561	0.55
31.12. 2006	69.09	24	0.585	0.62
31.05. 2004	70.39	25	0.610	0.70
31.03. 2003	73.20	26	0.634	0.79
31.01. 2002	74.86	27	0.659	0.87
31.08. 2003	74.87	28	0.683	0.96
30.06. 2004	78.16	29	0.707	1.06

Table 3.5 Continued

Month (1)	Max. Gust (Km/hr) (2)	Rank R (3)	Frequency F (4)	Reduced Variate y (5)
30.11. 2006	79.94	30	0.732	1.16
31.12. 2002	80.96	31	0.756	1.27
30.04. 2004	88.07	32	0.780	1.39
31.08. 2004	97.65	33	0.805	1.53
30.09. 2004	98.15	34	0.829	1.67
31.07. 2002	100.68	35	0.854	1.85
30.09. 2006	103.39	36	0.878	2.04
31.03. 2002	103.77	37	0.902	2.27
31.08. 2006	107.87	38	0.927	2.58
31.07. 2004	108.96	39	0.951	2.99
31.08. 2002	110.10	40	0.976	3.72

Equation 24 is plotted in Fig. 3.11 and seems to fit through the field data in an acceptable manner. Extrapolation from that equation may be used for return periods beyond the present record.

The above technique is similarly followed for the 7 other stations at Ado Ekiti, Akure, Ikeja, Iwo, New Airport (Ibadan), Old Airport (Ibadan), Oshogbo. Similar graphs Fig. 3.12 – 3.19 are obtained and correspondingly similar equations to that of equation 3.98 are prepared as shown in Table 3.6. After this, the technique was adopted to calculate the maximum speed in the Zone (Fig. 3.20). It must be noted, however, that the numbers in Table 3.6 are corresponding to those in Fig. 3.12 – 3.19.

Table 3.6 Best Fitting Lines for Eight Stations in Western Nigeria

No	Station	Representative Equation
1	Abeokuta	$V_{\max} = 58.81 + 18.9Y$
2	Ado Ekiti	$V_{\max} = 37.50 + 17.4Y$
3	Akure	$V_{\max} = 39.80 + 17.4Y$
4	Ikeja	$V_{\max} = 61.79 + 22.0Y$
5	Iwo	$V_{\max} = 47.95 + 18.4Y$
6	New Airport, Ibadan	$V_{\max} = 45.01 + 18.1Y$
7	Old Airport, Ibadan	$V_{\max} = 42.62 + 17.9Y$
8	Oshogbo	$V_{\max} = 54.03 + 17.9Y$
9	Western Nigeria zone	$V_{\max} = 90.88 + 11.5Y$

3.9.1 Correction for the Maximum Speed

Obviously the maximum velocity (V_{\max}) for a return period of T years is in fact a statistical average, based on the mean value of several T-years. Thus if the return period T is increased, the percentage risk in selecting any design speed is decreased. Taking the example of Western Nigeria, Table 3.7 demonstrates the increase in the design speed at different calculated risks and at different structures desired lives. For example a factor of safety of not less than 1.87 times the average maximum velocity (V_{\max}) is adequately needed if a structure of 100 years lifetime is to be constructed with a marginal risk not exceeds 10%.

Table 3.7 Maximum wind speed in Western Nigeria ($VD_{\max} = 90.88\text{Km/hr}$) at Different Desired Lives and Different percentages of Risk

Desired (Yr)	20			50			100		
Calculated Risk	0.632	0.300	0.100	0.632	0.300	0.100	0.632	0.300	0.100
T (yr)	20	56	187	50	157	530	100	315	973
V_{\max} (m/s)	125	137	151	137	149	163	144	157	170
$\frac{V_{\max}}{VD_{\max}}$	1.38	1.51	1.66	1.51	1.64	1.79	1.58	1.73	1.87

Other corrections are necessary, for height, orientation factor, topographical and for gust period. This estimate may well be beyond the natural period of the structure, in which case a correction factor must be added.

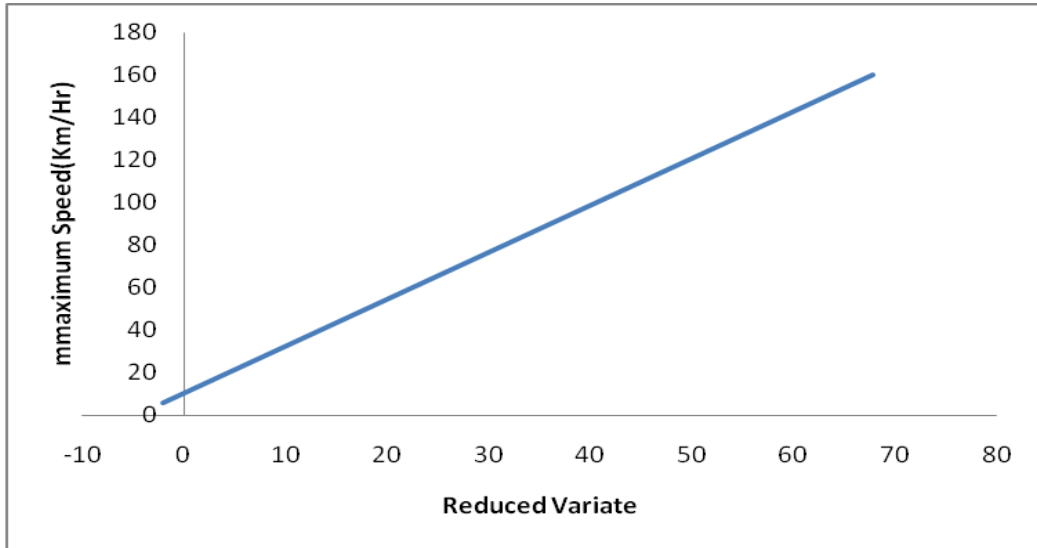

Fig 3.10: Design Speed at Abeokuta

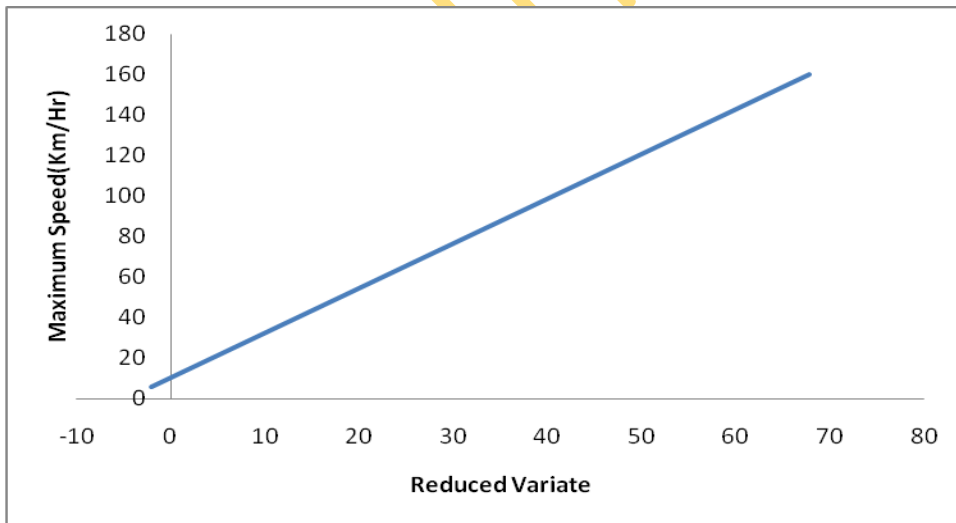

Fig 3.11: Design Speed at Ado Ekiti

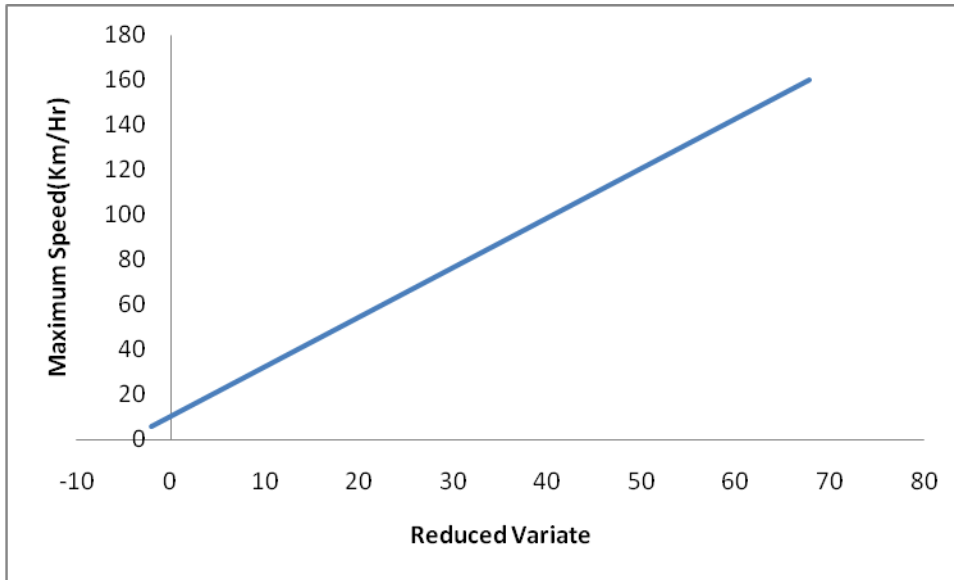

Fig 3.12: Design Speed at Akure

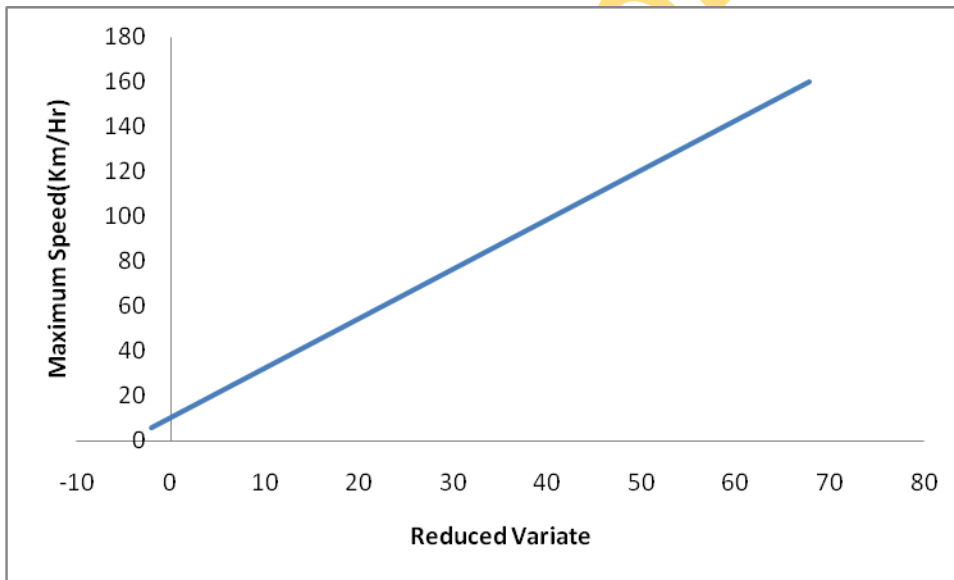

Fig 3.13: Design Speed at Old Airport Ibadan

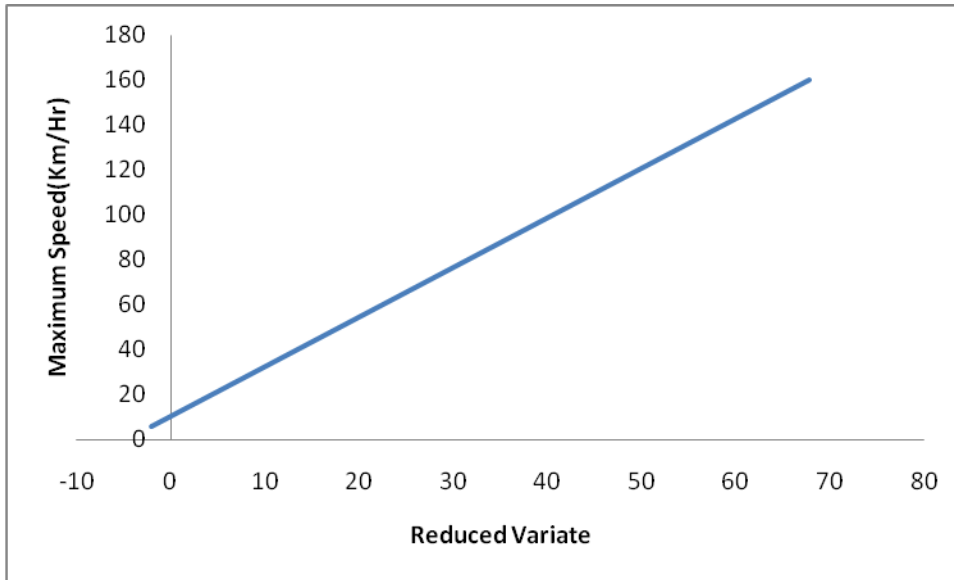

Fig 3.14: Design Speed at New Airport Ibadan

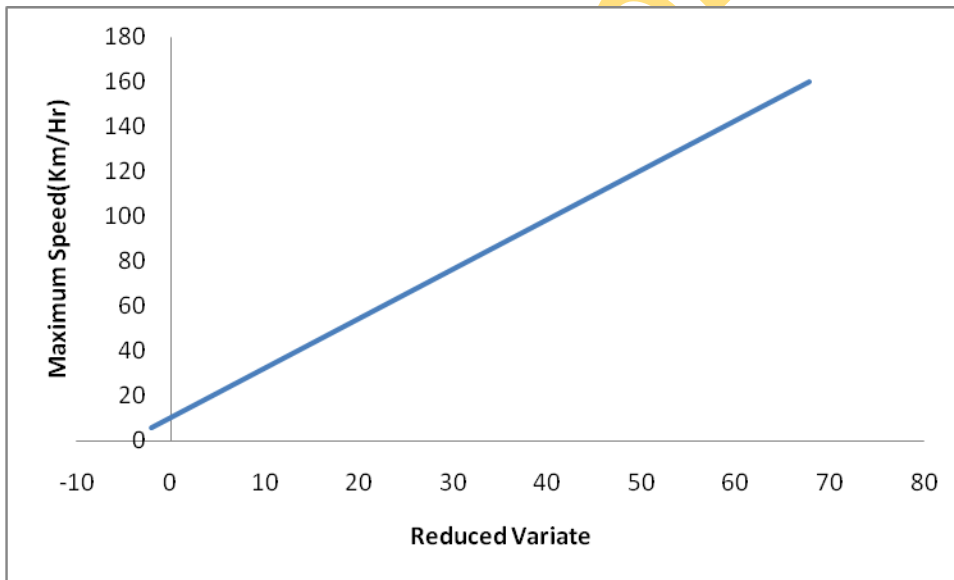

Fig 3.15: Design Speed at Ikeja

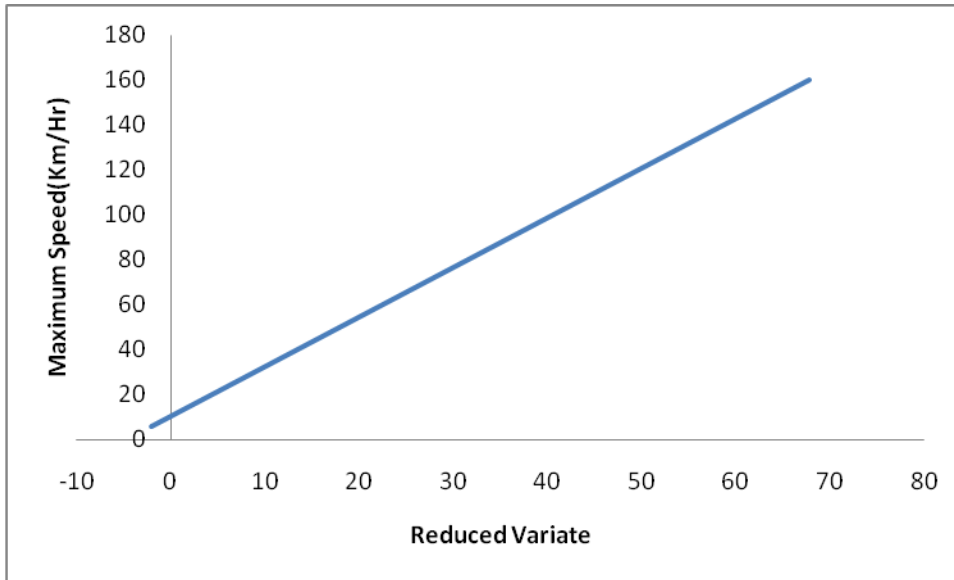

Fig 3.16: Design Speed at Iwo

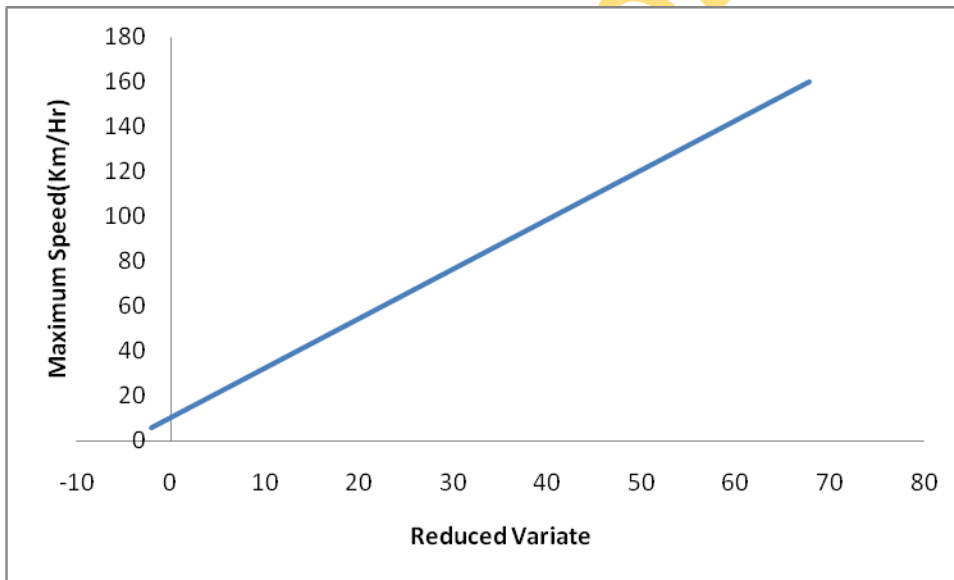

Fig 3.17: Design Speed at Oshogbo

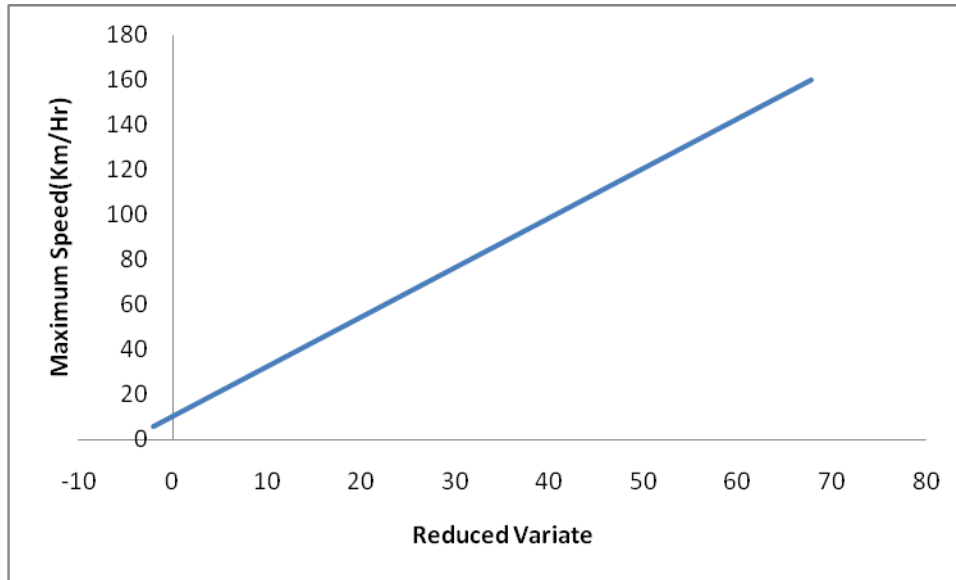

Fig 3.18: Design Speed in South-Western Nigeria

3.10 The Model Description

$$\text{Air weight (AW)} = \rho_{ai} \times \text{attic volume} \times g \dots\dots\dots \text{Eqn. 3.99}$$

$$\text{Wind force (WF)} = 0.5 \rho_{ao} \times V_s^2 \times Pa \times kg \times (C_L^2 \times C_D^2)^{0.5} \dots\dots\dots \text{Eqn. 3.100}$$

$$Pa = 0.25B^2 \tan\theta \times Ca \times AR \dots\dots\dots \text{Eqn. 3.101}$$

$$0.75 (RW + AW) \times Y^1 \geq WF \times B \tan \theta / 2 \dots\dots\dots \text{Eqn. 3.102}$$

Where

ρ_{ai} = Air density in the attic, (kg/m³)

ρ_{ao} = Ambient Air density, (kg/m³)

g = Acceleration due to gravity, (m/s²)

Ca = Angle of orientation factor, (degree)

AR = Area ratio factor, (m²)

Y^1 = Centre of pressure, (m)

V_s^2 = Design wind speed, (m/s)

B = Breadth of the building, (m)

Kg = wind gust factor

CD = coefficient of drag

CL = Coefficient of lift

θ = Roof pitch angle, (degree)

3.11.0 Development of a Software Program to Predict Roof Blown - Off

A software program was written in FORTRAN to predict roof blown off. The program development came after the mathematical equation

$MW > MR$, for blown off to occur

UNIVERSITY OF IBADAN

CHAPTER FOUR

RESULTS AND DISCUSSION

4.1 Survey Results.

The types of buildings surveyed cut across industrial (2 per cent), residential (80 per cent), religious (4 per cent), educational (8 per cent) and others (6 per cent); with ages varying from recent construction to as much as 40-year-old roofs. These roofs included those that appeared to be in good condition and those that had collapsed. Those that appeared sound but were found with defect were considered in the analysis of results, while those without defects were discarded. A total of 1894 roofs which is 50.1% of the total roofs surveyed across the study area were identified with one form of defect or the other. The roofs that were discarded were the roofs that were considered to meet the structural, aesthetics and functional requirements of building roof.

4.1.1 Age of Building Roofs

Of the total 1894 building roofs associated with one defect or the other, those ranging between 10 – 19 years in age constituted about 25.87% while those built more than 40 years ago constitute about 20.49. Building roofs within the age range of 19 – 40 years constituted 41.76% and buildings with ages 0 – 9 constituted 11.88 %. These data are presented in Table 4.1.and Figure 4.1. The implication of this is that roof of all ages failed with various reasons. It was established that roof defects does not depend on age as it was discovered that roofs of recent construction experienced one form or failure or the other.

Table 4.1: Age Distribution of Building Roofs

Ages (years)	No. of Building Roofs	Percentage
0 – 9	225	11.88
10 – 19	490	25.87
20 – 29	405	21.38
30 – 39	386	20.38
40 +	388	20.49
Total	1894	100

Source: Field Survey (2009)

4.1.2 Roofing Systems

The most popular roofing system in Southwestern Nigeria is the pitched roof system. This type of roof registered 55.33% of the total of 1894 failed roofs. Following pitched roof are flat, combined and concrete roof having registered 15.33%, 13.83% and 12.78% respectively as contained in Table 4.2.

Table 4.2: Distribution of Roofing Systems

Type	No. of roofing Systems	Percentage
Pitched	1048	55.33
Flat	302	15.95
Concrete	242	12.78
Combined	262	13.83
Others	40	2.11
Total	1894	100

Source: Field Survey (2010)

4.1.3 Roof Designer

The survey revealed that less than 50% of the number of buildings investigated, were designed by trained architects/Engineers (48.47% precisely), 46.46% by carpenters and the remaining 5.07% were designed by the owners of the buildings themselves and the contractors to whom construction of the buildings were awarded. Most problems of roofs emanated from the 46.47% and the 5.05% that totaled 51.53% as shown in Table 4.3. This group has no formal education that can adequately analyze roof system and the anticipated loads on them during their life time. The reasons for this are due in part to the fact that there are no strong government policies on roofing construction in the country and in part due to the low economy of majority of house owners. They result to the use of artisans because of the high cost of employing trained professionals.

Table 4.3: Distribution of Roof Designers

Type	No. of Building Roofs	Percentage
Architect/Engineer	918	48.47
Carpenter	880	46.46
Others	96	5.07
Total	1894	100

Source: Field Survey (2010)

4.1.4 Roofing Sheathing Materials

Zinc cladding is the most popular roof sheathing material in the study area with 59.48%. This implies that it is the most adopted by the people. This is followed by asbestos material with 23.28%. Aluminium and concrete has 8.64% and 7.76% respectively as shown in Table 4.4 The low usage of concrete is partly attributable to cost of construction, tropical climate of the area and also not encouraged due to high cost of maintenance. Since concrete is not a water retaining structure, there is the need to apply roof felt on top of concrete which will easily fail in the tropics. The spread in the use of other various sheathing materials is influenced by the economy of the house owners, aesthetics and ready availability of materials.

Table 4.4: Roof Sheathing Materials

Type	No. of Buildings	Percentage
Zinc	1127	59.48
Aluminium	147	7.76
Asbestos	411	23.28
Concrete	164	8.64
Others (Tile)	15	0.84
Total	1894	100

Source: Field Survey (2010)

4.1.5 Major Inadequacies

During the survey, house owners interviewed were positive or agreed on the need to change if possible or improve their roofing system. The house owners also complained on the

issue of excess heat in the house implying roof failure to properly regulate the temperature as contained in. Table 4.5

Table 4.5: Major Inadequacies

Answer	No. of Respondents	Percentage
Aesthetics and Beauty	50	15.15
Poor house inner temperature	160	48.48
High cost of installation	30	9.09
Weather non-resistance	90	27.27
Total	330	100

Source: Field Survey (2010)

Majority of the dissatisfaction discovered from the roofs in the zone is due to the high temperature experienced in the zone. The roof designers in the zone are yet to find solutions to the issue of discomfort in the building and weather resistance capacity of roofing materials

4.1.6 Roof Truss Materials

The most popular truss material in the region is timber representing 66%. This is followed by raffia palm that is predominant in the rural areas accounting for about 19%. The popularity of raffia palm in the rural area is probably due to availability, economy, durability and properties.

Table 4.6: Roof Truss Materials

Type	No. of Respondents	Percentage
Timber	1250	66
Raffia Palm	360	19
Concrete	208	10.98
Steel	76	4.01
Total	1894	100

4.1.7 Roof Failures

During the survey, about eleven types of roof failure patterns were identified in the zone. These failure patterns are highlighted in Table 4.7. Roof rust, leakage and nail withdrawal are the most noticeable failures in the zone with about 47.00%, 46.6% and 42.76% occurrences respectively. Blow-off is the least with 14.73% occurrence followed by asbestos discoloration with 18.48% occurrence and ponding with 20.22% in that order. The rest types of failure that occupy the middle are wood decay 38.01%, sagging 36.80%, Tearing-off 32.00%, Truss damage 29.99% and Open lap 23.97%

Roof failures are encouraged by low pitch (less than 25⁰). Most of the roofs in this zone fall within the category of low pitched roof, characterized with inadequate web, insufficient diagonal bracing of trusses, poor structural joints and lack of maintenance.

Table 4.7: Distributions of roof failure patterns

S/N	Types of Failure	2007	2008	2009	Total	% based on the 1894 failed roofs
1.	Rust	350	406	153	909	47.99
2.	Leakage	330	400	150	880	46.46
3.	Nail withdrawal	240	350	220	810	42.76
4.	Wood decay	360	220	140	720	38.01
5.	Sagging	341	229	127	697	36.80
6.	Tearing off	286	200	120	606	32.00
7.	Truss damage	250	195	123	568	29.99
8.	Open lap	180	154	120	454	23.97
9.	Ponding	130	170	83	383	20.22
10.	Decolouration	142	134	74	350	18.48
11.	Blown-off	100	119	60	279	14.73

Source: Field Survey (2009)

4.1.8 Indices of Roof Failures

Failures in roofs can be identified by various methods which include visual observation, physical measurements and calculations. These indices which were employed during this study are presented in Table 4.8 and are further discussed.

Table 4.8: Indices of Roof Failures

S/N	Failure Type	Indices
1	Blown off	Lifting and carrying away of total or part of the roof
2	Sheet removal	Detachment of sheet coverings from trusses but trusses remain in place
3	Nail removal	Gradual withdrawal of nail fasteners from roof members.
4	Rust and/ or discolouration	Change in colour of sheet covering materials from shining or grey to rusty colours
5	Truss Damage	Tearing of or broken truss of a roof
6	Wood Decay	The texture is softened and the wood disintegrates.
7	Leakage	When the roof covering can no longer exclude rain water from penetrating into the house
8	Open lap	When the sheeting overlap is open to ingress of water
9	Sagging	When roof cave-in in such a way as to cause an excessive deflection than stipulated in the code
10	Ponding	Collection of water on roof due to inadequate drainage on the roof.

Source: Field Survey (2009)

a) Roof Blow-off

This is the total or complete removal of the entire roofing system from a building. When wall plates are not properly connected to the wall, it results in roof blown-off by frequent heavy storms. Light weight roof systems are very vulnerable to lifting by suction. When the suction effect exceeds the weight of the roof, the tendency is for the roof to be lifted. The effect of roof blown-off is that it renders the structure which the roof is covering completely useless for the purposes it is intended to serve.

Survey revealed that roof blow-off is most prevalent during the month of April and October recording about 34.05% of total blown-off records. This was shown in Table 4.9 Roof blown-off is also found to be more pronounced on hill top because of higher wind speeds resulting from the venturi effects of the hills as contained in Table 4.10 with gable roof most adversely affected as in Table 4. 11. The survey validates the model in section 3.7.4; gable roof was more prone to blow-off than hip roof because hip roof has less area of attack and contain more materials than gable roof. Rural areas experienced blown-off more than urban cities, this was shown in Table 4.12. Air pressure is a little higher in the relatively cool thick forest surrounding the rural areas and because of the heating activities going on in the villages and the heating effect of sun on the exposed land surface, air in response to pressure differential move to the village. The greater the pressure differential, the greater the wind speed, On the contrary, the effect of industrial activities in the cities keep the temperature relatively uniform creating no case or little pressure differential, which makes wind flow to be very slow or relatively still in the towns. This may probably be the reason why harmattan is more severe in the rural areas than in the cities

Table 4.9: Roof blow-off pattern in the year 2007 - 2009

MONTH	Number of Occurrences	%
April	95	34.05
May	40	14.34
June	15	5.38
July	2	0.72
August	3	1.08
September	35	12.54
October	89	31.9
TOTAL	279	100

Source: Field Survey (2010)

Table 4. 10: Roof blow-off pattern based on topography location

LOCATION	FREQUENCY	%
Plain	89	32.00
Valley	44	15.67
Up-Hill crest	146	52.33
Total	279	100

Source: Field Survey (2010)

Table 4.11: Blow-off based on roof Geometry

Type	No. of Occurrences	Percentage
Gable roof	158	56.63
Hipped/ Dutch gable roof	41	14.70
Flat roof	80	28.67
Total	279	100

Table 4.12: Rural- Urban Pattern of Roof Blow-off

Location	No. of Occurrences	Percentage
Rural	182	65.23
Urban	97	34.77
Total	279	100

Roof Blown-off



Plate 4.1: Roof Blown-off

b) Sheet Removal

Positive wind pressures on roof surfaces tend to strip off roofing coverings composed of small units such as zinc and asbestos. Weak or low nailing density of most roofs makes them also vulnerable to wind damage. This failure is very dangerous as flying sheets could cause harm to individuals if hit by the sheet. Also flying sheets could also destroy other neighbouring roofs. If sheets are removed and are not quickly replaced, it could cause the total collapse of the roofing system

Sheet Removal



Plate 4.2: Sheet Removal

c) Nail Withdrawal

This is the gradual withdrawal of nails from the roof members. This is caused by the effects of swelling and shrinkage of the wood members in the trusses and the effect of stress reversal caused by the actions of wind on the sheathing materials. Air flows through the holes of the corrugation causing the vibration of the sheathing. Although the effects of this action may not be such as to cause immediate failure on the roof, as years roll by, this continuous action of wind load on the roofing sheets could cause fatigue loading that will induce nail withdrawal. Nail pulling can also be caused by the swelling and shrinkage of intermittently wetted wood, caused by seepage. The effects of this type of failure are that the roof members are weakened and this can lead to other failures such as sheet removal, leakages and sagging.

Nail Withdrawal



Plate 4.3: Nail Withdrawal

d) Rusting of Iron Sheets

Frequent rains allow water sufficient time to attack the roof coverings. Precipitations in some areas contains diluted salts which result from evaporated water from the oceans, combined with carbon dioxide in the atmosphere to form acidic substances dissolved in the rain. These acidic solutions present in rain waters react with the roof covering materials to accelerate the rate of corrosion and decay. Though this failure is considered more to be aesthetic failure, it has some negative impacts on the roof functionality. In the tropical climates, heat is the problem. The building for the greater part of the year serves to keep the occupant cool rather than warm hence the heat reflective capacity of roof is hindered when the coverings are rusted. Rust roof will also promote roof leakage as the surface encourages deposit of sand particles in the grooves of the roof covering materials. This will reduce water flow rate which can encourage leakage.

Rust



Plate 4.4: Rust

e) Asbestos Discolorations

Continued dampness on asbestos roofing sheets lead to discolouration and the growth of fungus on the roof. This failure is promoted by gentle slope, small grooves of the roof covering materials and heavy precipitations. This is also an aesthetic failure, as it reduces the beauty of the roof system. When this failure occurs, it brings with it attending menace of slippery nature. If any worker who attempts to work on the roof is not careful, he can slip off resulting in to serious injury

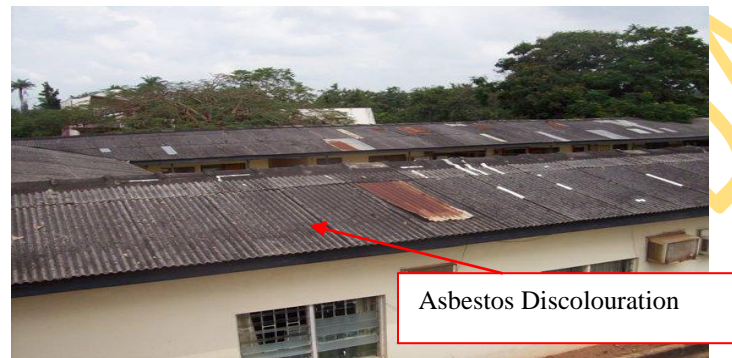

Plate 4.5: Asbestos Discolouration

f) Truss Damage

This is also a common problem associated with wooden trussed roof. Damage to the truss will lead to damage configuration and eventual leakage of the roof. Causes of damaged wooden truss could be as a result of timber failure resulting from defects such as shakes, checks, knots, and splits. Exposure of timber to moisture tends to counteract the effects of the seasoning of timber. Timber takes up moisture form the atmosphere and expand in doing so. Another source of damage to the trusses is the situation when the enclosed chambers by timber roofs are warm and poorly ventilated, damp condition occurs which are conducive for the multiplication of fungi which reduce the timber quality. The effect of this failure is that it paves way for other failures such as blown-off, leakage, sagging and sheet removal.



Plate 4.6: Truss Damage

g) Wood decay

Wood decay is the gradual disintegration of wood grains by the action of fungi causing reduction in size and loss of strength in wood. Water often goes through the cracks in the wall copings to dampen the walls and timber frame work thereby causing wood decay. This water gets to the crack by precipitation, when there is an opening in the roof; water gets into the roof frames. A roof soon loses its integrity once water penetrates it due to the failure of its roof covering. Water speeds up the decay process by its oxidising effects. In humid weather it is possible for the timbers in the roof to absorb moisture from the atmosphere, causing them to expand. This condition also exposes timber to dry rot. Wood decay can lead to other forms of failures such as nail withdrawal; sagging; leakage and even total collapse.



Plate 4.7: Wood Decay

h) Leakages

This is failure associated with the damage of the roof covering materials. Leaks also often occur where pipes or vents penetrate the roof membrane, as well as at roof perimeters where roofing systems change from one material to other materials. Small slopes can encourage leakage in the roof because the speed of water flow depends on the roof slope. The menace of this particular failure is that it may some time prove difficult to identify the exact location where the leakage comes from. Water penetrating a defective roof covering may be conducted to a point remote to its entry, and will not be detected until the roof is opened. Improper fixing of roofing members, accidents such as throwing stones and other objects on the roof, other failure such as sagging, nail withdrawal and rusting of the sheathing materials could lead to this failure. This failure poses danger to the safety of properties in the building especially with its easy exposure of the properties in the building to water. Roof trusses, particularly wood members are at greatest risk of damage through water penetrations from roof leakages.

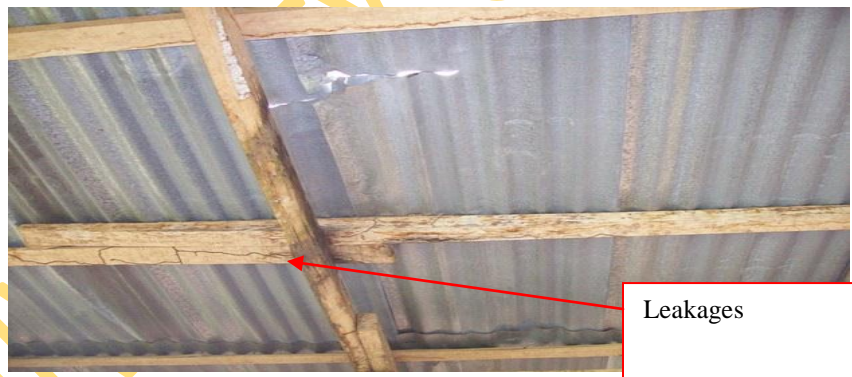

Plate 4.8: Leakage

i) Open Lap

This failure results from inadequate lapping of roof covering materials. It can also occur when the purlin bearing the sheeting materials are not straight and level. Roof coverings are supposed to be fixed in such a way as to have sufficient overlap. In corrugated coverings, the overlap is a minimum of one pitch at the side and distance sufficient to prevent possible leakage

and for proper articulation at the tops. The top overlap is arranged such that subsequent sheets (beginning from the apex of the roof) have their ends resting on top of the starts of the next sheet



Plate 4.9: Open Lap

j) Sagging

This is the excessive deflection of the roof members beyond the Code specification. Sagging may occur as a result of under estimation of roof load during design which results in inappropriate spacing of trusses and purlins. Also sagging may occur where the roof span is extremely too large for the truss material to support the roof. Another reason for this type of failure is the inadequate lapping provided during joints constructions. This failure is not considered as constituting danger to the occupants of the building; hence not much attention is paid to it. The effect of it is that aesthetics of the roof is impinged and also it could lead to other types of failure such as leakages and wood decay.



Plate 4.10: Roof Sagging

4.2 Experiments Results.

The findings from the experiments are hereby presented:

4.2.1 Moisture Contents

Table 4.13 below presents the results of moisture content test of wood in service

Table 4.13: Results of Moisture Contents Determination

Specimen	Wet weight (grams)	Oven-dry weight (grams)	Moisture Content % (Dry basis)
Mansonia	9.07	7.77	17%
Omoo	5.70	5.10	12%
Gmelina	5.57	4.50	24%
Ayin	9.70	8.47	15%
Oroo	8.42	7.26	16%
Teak	8.73	7.67	14%
Wood in Use	1.78	1.67	7%

The implications are that the wood specimens which were assembled at moisture content above 7% will shrink across the grain while drying to 7% MC and the wood would therefore be compressed across its width, causing it to induce stress on the wood members. This will in effect

cause interface gap in the joints. It therefore suggests that the assumed wood stress value at low moisture content during design may lead to overestimation of the strength of that joint in service if the trusses are assembled using green lumber which subsequently dries out

4.2.2 Corrosion Tests

Weight loss data are summarized in Table 4.14 and with corresponding graph in fig. 4.12; corrosion was less in nails of big diameter than those of small diameter. This is a reversal of anticipated results, since the area in contact with moisture in the bigger diameter nails is more than smaller nails. 25mm nails had a maximum weight loss of 30% and had a reddish brown color at end of test. After the ninety days of accelerated exposure, annularly threaded and zinc nails had least weight loss of between 7.4-11%.

Table 4.14: Weight loss in Nail

Nail Size	Test Duration in Days							
	0	10	20	30	40	50	60	90
25mm	1	0.791	0.787	0.786	0.786	0.773	0.77	0.706
37mm	1.2	1.052	1.051	1.049	1.049	1.032	1.027	0.932
50mm	2.5	2.284	2.28	2.275	2.275	2.249	2.245	2.04
75mm	7	6.689	6.687	6.683	6.683	6.623	6.618	6.295
100mm	14	13.557	13.553	13.544	13.544	13.423	13.408	12.826
125mm	21	20.876	20.869	20.852	20.852	20.706	20.687	19.907
150mm	34.886	34.84	34.838	34.78	34.78	34.543	34.501	33.379
Annularly threaded	9	8.848	8.847	8.844	8.844	8.766	8.759	8.384
Adex roof nail	8.5	8.268	8.261	8.225	8.225	8.139	8.127	7.58

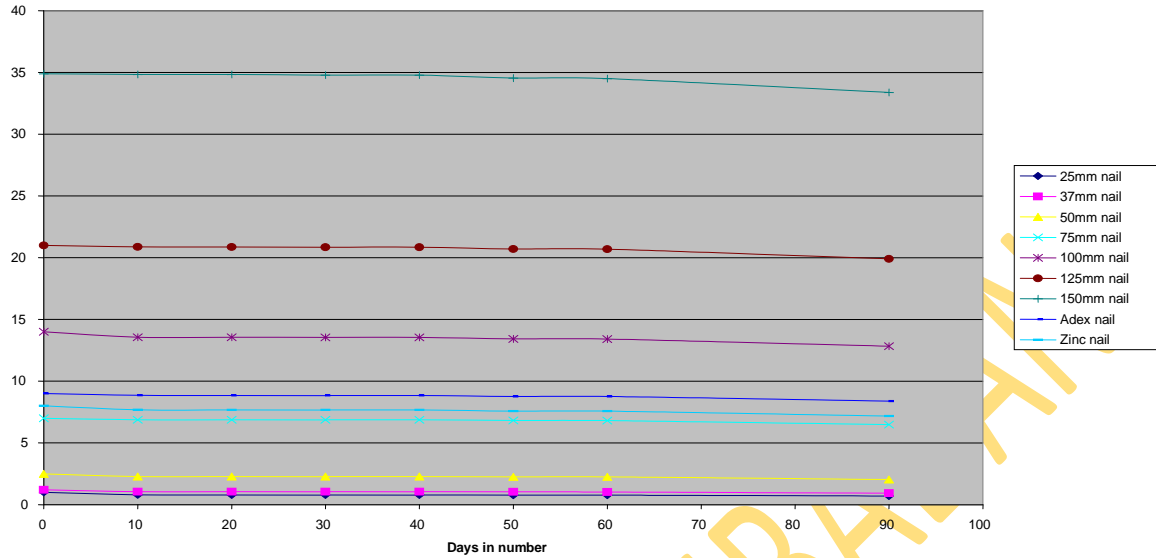

Fig. 4.1: Weight loss in Nails

The results revealed that the designed load joints are affected by the high moisture in the zone. This high moisture reduced the nail diameter invariably reducing the holding capacity of nails in roof joint.

4.2.3 Temperature Fluctuations

Table 4.15 shows the result of temperature variations in the roof and the environment. The roof temperature is generally high throughout the year and the annual range is usually low, between 3° and 6°C. Durability or service life of a roof is to a large degree dependent upon the temperatures it experiences.

High temperatures increase the rate of deterioration of many roof materials through acceleration of the photo-oxidative processes. Temperature rise produces sufficient expansion of small quantities of air or moisture trapped in the attics of a roof to cause stress on roof materials. Both high and low interior surface temperatures influence comfort conditions, and low values may determine the relative humidity permissible in the space below.

As a result of daily and seasonal changes in air temperature, solar heating and radioactive cooling, temperature variations occur that cause building materials to change their dimensions. If this is restrained it produces stress and perhaps warping in the restrained

Table 4.15: Daily Temperature Variation in °C

Date	8.00am		12.00 noon		4.00 p.m		8.00 p.m	
	Roof	Ambient	Roof	Ambient	Roof	Ambient	Roof	Ambient
11-09-2003	24	22	31	26	31	31	25	27
12-09-2003	24	23	30	24	30	31	24	25
13-09-2003	25	22	32	28	29	30	25	25
15-09-2003	24	22	38	31	32	33	22	24
16-09-2003	24	24	34	34	32	32	23	26
17-09-2003	24	22	31	37	31	32	24	26
18-09-2003	21	21	33	30	31	22	22	24
19-09-2003	22	22	32	31	32	30	23	23
20-09-2003	23	23	35	35	33	32	27	28
21-09-2003	25	24	35	32	35	36	24	26
22-09-2003	24	23	28	32	36	33	26	28
23-09-2003	23	22	30	30	37	33	26	25
24-09-2003	26	26	33	32	30	28	23	24
25-09-2003	25	23	28	37	36	29	20	25
26-09-2003	23	23	34	35	38	32	22	24
27-09-2003	25	23	30	39	36	29	26	27
29-09-2003	25	25	35	37	34	35	21	26
2-10-2003	25	22	35	38	28	32	23	24
4-10-2003	29	27	28	30	35	39	24	26
5-10-2003	23	25	30	30	30	33	26	27
6-10-2003	23	23	36	36	30	35	25	27

Table 4.15 continued

Date	8.00am		12.00 noon		4.00 p.m		8.00 p.m	
	Roof	Ambient	Roof	Ambient	Roof	Ambient	Roof	Ambient
7-10-2003	23	23	28	30	32	36	25	25
8-10-2003	23	23	32	33	28	34	24	27
9-10-2003	25	26	35	37	30	40	24	28
10-10-2003	25	25	31	32	33	35	22	26
11-10-2003	25	24	35	35	33	35	21	26
13-10-2003	28	23	31	40	33	35	23	26
14-10-2003	23	22	34	34	29	32	24	25
15-10-2003	24	24	30	33	25	36	25	25
16-10-2003	29	25	31	31	30	37	20	25
17-10-2003	21	22	31	37	35	39	26	26
18-10-2003	23	23	37	37	35	39	23	26
20-10-2003	24	24	32	36	34	37	24	27
21-10-2003	33	39	35	31	25	38	27	27
22-10-2003	23	23	31	34	33	37	21	26
23-10-2003	25	26	30	35	29	33	20	26
24-10-2003	24	24	32	36	31	39	22	23
28-10-2003	27	26	34	38	31	31	24	27
29-10-2003	27	35	34	32	35	34	28	35
30-10-2003	21	26	36	36	35	38	26	34
31-10-2003	25	25	31	35	36	35	27	32
1-11-2003	25	23	33	36	36	36	22	27

Table 4.15 continued

Date	8.00am		12.00 noon		4.00 p.m		8.00 p.m	
	Roof	Ambient	Roof	Ambient	Roof	Ambient	Roof	Ambient
3-11-2003	23	25	33	34	30	38	23	27
4-11-2003	33	34	35	38	33	38	23	28
5-11-2003	33	34	35	34	35	38	24	28
6-11-2003	31	33	36	38	36	38	23	29
7-11-2003	29	28	30	32	30	36	24	29
1-12-2003	24	24	33	35	30	37	25	26
2-12-2003	33	33	38	40	37	40	23	29
3-12-2003	24	23	30	33	30	35	23	27
4-12-2003	29	28	35	36	30	34	24	27
5-12-2003	26	26	33	35	35	37	22	29
6-12-2003	28	28	35	38	32	38	26	29
7-12-2003	22	24	35	32	31	39	25	29

Source: Field Survey (2010)

From the results above, using student's "t" method of statistical analysis, it was revealed that roof temperatures in the zone are significantly different from ambient temperature at 5% confidence level at 8:00 a.m, 12:00 noon and 8:00 pm; but they are however not significant at 4:00 pm. Between 8:00 a.m and 4:00 pm, the roof temperature is higher than the ambient temperature while the roof temperature is lower than the ambient temperature at 8:00pm. The average temperatures are 25.3°C, 23.4 °C; 32.8 °C, 34.0 °C; 32.3 °C, 32.1 °C; 23.8 °C, 26.5 °C for both roof and ambient temperatures at 8:00 am; 12:00 noon; 4:00 pm and 8:00pm respectively.

4.2.4 Effects of Interface gaps

Interface gaps are encouraged in joints to ensure durable and efficient roof joint system with adequate rigidity. Table 4.16 shows details of joint test results with varying gaps within members.

Table 4. 16: Details of Joint Test Results

		Experimental value	Expected value	Experimental as a percentage of expected value
Joint Type	Joint Description	Load (Kg)	Load (Kg)	Percentage (%)
Type 1	Joint with 6mm gap	97.8 (5.98)	103.1 (8.29)	94.9
Type 2	Joint with 12mm gap	88.7(4.95)	103.1 (5.6)	86.0
Type 3	Joint with 18mm gap	82.6(17.09)	103.1 (5.45)	80.1

Table 4.16 above shows the average values and coefficient of variations of each type of joint. It can be seen from the Table that the effect of a gap becomes more significant at proportional limit slip as the gap increases. The reduction in joint strength could be as high as 20%. This results revealed that interface gap in a joint lowers joint strength which might lead to failure such as truss damage, sagging, ponding and blown-off.

4.3 Model Validation

The model has been validated with field data that were not part of the design and compared with existing literature. The full details of the predictions are shown in Appendix 8

4.3.1 Design Speed

Modeled design wind speed in the zone is 97.11Km/ hr. This compared favorably with 93.6Km/hr observed highest wind gust in the Zone.

4.3.2 Effect of Angle of Attack

The placing of buildings in relation to one another, and with due regard to sun and wind, demands considerable attention in judging the layout of residential development. Nevertheless,

as a general rule of thumb, a layout which attempts to align the frontages of the dwelling in an approximately north to south direction is preferable to one whose orientation is west to east. In this way both the back and the front of the buildings will receive sunlight, one in the morning, the other in the afternoon and early evening. The light in the south at midday is not really lost, because it has least penetration owing to its elevation in the sky. The factor of orientation assumes even more importance in the location of high-rise, high density development where not only the penetration of sunlight but also the effect of shadow and wind become significant. This module has therefore predicted that the critical angle of attack is when a building is at 45° orientations to the main wind direction. For the orientation factor the maximum contact area is at $\alpha = \tan^{-1}(Z/b)$ and the value of the contact area is $Z \sin \alpha + b \cos \alpha$, where Z is the length of the building and b is the breadth. This explains why long buildings suffer more than short buildings at even the same angle of orientation.

4.3.3 Effect of Topographical Location

The model showed that a relation between the wind speed at the heel of a hill and at the summit of the hill could be given as

$$V_s^2 = 0.9984 \frac{h(h+2y)}{(h+y)^2} \left(\frac{(\sin \phi + \cos \phi)^{\frac{9}{7}}}{(\cos \phi + \sin \phi)} - \frac{(\sin \phi)^{\frac{9}{7}}}{\cos \phi} \right) \quad \text{Eqn. 4.1}$$

The implication of the above formula is that the distance of full shelter protection of a given wind breaker reduces uphill resulting in greater wind effect on top of hills.

4.3.4 Effect of Roof Geometry

The two major roof geometries in the zone are hip and gable. The gable roof is more prone to uplift under wind load than hip roof because hip roof contains more materials than gable roof and the area of exposure in gable roof is more than in hip roof. Due to their complex internal framing and steepness in pitch, wind is prevented from entering underneath the roof shingles, and the overall shape of a hip roof provides durability against wind. The four slopes constituting a hip roof create an eave running all the way around the building, which in turn creates an overhang that can protect against sun and rainfall

4.3.5 Effect of pitch Angle

The weight needed for a truss to support itself is given by the relation

$$W = \frac{ql\rho(1 + \cos^2\alpha)}{b\sin 2\alpha} \quad \text{Eqn. 4.2}$$

Minimising the weight by differentiating with respect to b, the optimal pitch angle for self support of roof trusses was discovered to be 55° . The analysis revealed that the higher the pitch angle the lesser the stress experienced by the truss members as shown in Figure 4.13

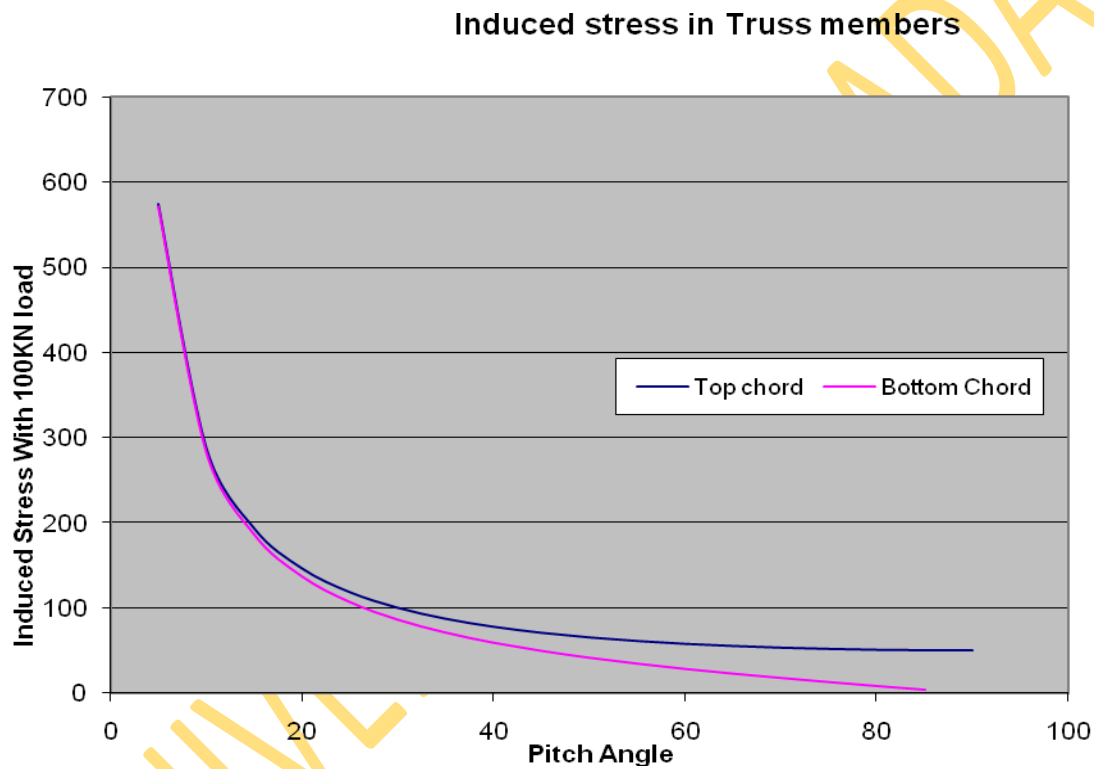

Fig.4.2: Induced Stress in Truss Members

4.3.6 Effect of Courtyard

The time required to fill a courtyard of radius 'a' is given by the formula below.

$$\tau = 0.915 a (\rho / P_0)^{0.5} \quad \text{Eqn. 4.3}$$

From the above it will take some time for air to fill in the courtyard and this will therefore reduce the drag effect of the wind on the roof structure. As wind flows over the roof, it leads to

uplift, the faster the wind flows over the roof the greater is the uplift, therefore when courtyard slows down the speed of passage over the roof, it reduces the tendency for uplift.

4.4.0 Remedial Measures

Roof failures can be minimized in the zone by taking some precautionary measures which involves some design, constructions, provisions of some amenities and maintenance practices.

The survey revealed that the four prominent types of failure in the zone are rust; leakage; nail withdrawal and wood decay. Although blown-off is the least failure in occurrence, its effect is more severe than any of the failures. Remedies of the above five cases will take care of the rest six. While treating blown-off, sheet removals could be addressed; in the same vein leakage treatment can take care of failures such as sagging, ponding wood decay and open lap. Rust can also be taken to mean discolouration, however asbestos do not rust but changes colour. Generally, in order to forestall roof failure table 4.17 below will guide on what could be done and for what.

Table 4.17: Precautionary Guide against Roof Failures

S/N	Guide Measure	Failures that will be prevented
1	Routine maintenance programme	All types of failure
2	Provision of adequate slope and roof overhang	Wood decay, rust/discolouration, blow-off ponding, leakage, nail withdrawal and sagging
3	Construction which include provision of adequate nail density and proper nailing, paying attention to edge distance, proper anchorage of rafters, good joints and use of well seasoned timber	Sheet removal, open lap, sagging and truss damage, blow-off, nail withdrawal and leakage
4	Provision of good roof drainage and drainage of the whole surrounding	Leakage, sagging, wood decay, and rust/discoloration
5	Provision of courtyard and enough openings well positioned in the roof	Blow-off, wood decay, sagging and leakage

Source: Field survey (2010)

4.4.1 Prevention of failure due to wind

In guiding against uplift by wind actions, the following measures could be adopted

4.4.1.1 Openings

The openings in a building should be positioned so as to allow cross ventilation so that during a windstorm, the wind forces could easily blow through the building to avoid the concentration of uplift forces on the underside of the roof, which will tend to uplift the roof. The critical stressed area on any roof surface are usually located on the eaves, verges and ridges, therefore the fastening of the roof covering materials to the roof structure should be such that the spacing of the fasteners are closer at these places than the other portions of the roof. Also provision of adequate vent at the ridge should be made to forestall internal pressure created at the

ridge. It is also suggested that thin foam should be placed between the sheathing material and the last purlin to prevent air from getting to the roof.

4.4.1.2 Courtyard

There should be adequate provision for courtyard to stem down the effect of wind on roof uplift. Roof damage caused by wind occurs when the air pressure below the roofing assembly is greater than the air pressure above the building's roof. As wind flows over the building, the pressure directly above the surface of the roof decreases. At the same time, internal air pressure increases due to air infiltration through media that include openings and cracks. As the wind flows over the roof, uplift occurs; the faster the wind flows over the roof, the greater the uplift. Roof with court yards reduces the time it takes a given mass of air to flow past a roof and also create better suction to draw air out of the roof invariably reducing the internal air pressure. Provision of courtyard in a building also serves as a means of temperature regulation and in venting the building.

4.4.1.3 Design of both Rafter and Purlin Spacing

The provision of high pitched roof will enhance stability and good structural performance of roofs in the zone, also the spacing of trusses and rafter must ensure that deflection criteria are met. To ensure this spacing must be such that:

$$S = \left(\frac{230.4EI}{W} \right)^{\frac{1}{3}}$$

Where S = spacing, mm

E = Modulus of elasticity (N/mm²)

I = moment of inertia (mm³)

W = uniformly distributed on the material to use (N/mm²)

4.4.1.4 Wall Plate

Anchorage should be properly provided for the wall plate, the anchorage length would be a function of bar diameter, concrete strength, and characteristic strength of the steel used. The anchorage bar should be provided at the spacing of the trusses. The idea of using metal strap nailed to hollow block wall should be reviewed in line with the present state quality of hollow sandcrete blocks. Fig 4.11a shows the usual practice while Fig 4.11b is the recommended way.

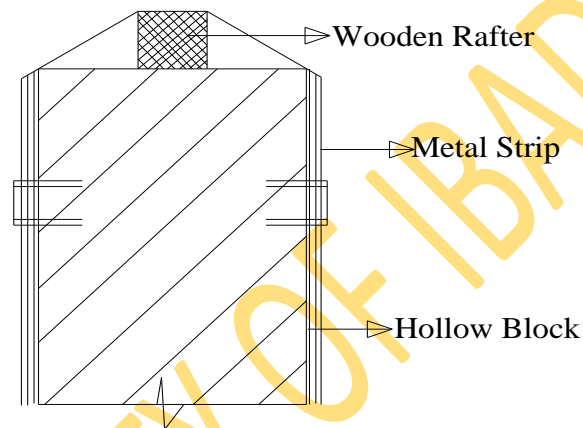

Fig 4.14a: Bad fixing of wall plate

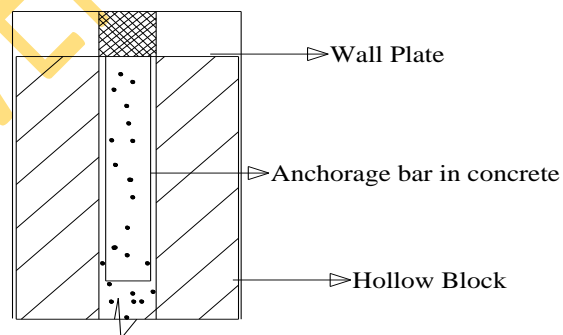

Fig 4.14b: Correct fixing of wall plate

4.4.2 Prevention of Leakages

In southwestern Nigeria, the climate is warm and humid with heavy rainfall. The design stability requirements of roof must include having sufficient roof slope and overhang. The steeper the slope of the roof the faster the roof drains. Sources of leakages in roofs must be found and immediately remedied to avoid any deterioration in the roofing members. All accidental damages must be repaired immediately they are detected. Regular and proper cleaning of roof gutters will ensure free flow of water from the roof. Defective member should be replaced immediately and as much as possible depressions should be avoided in the roof member. Leakage occurs when there is water on a surface, openings through which it can flow, and forces acting to move it inwards. If any one of these conditions is eliminated, water cannot enter. Similarly, if there are no openings, leakage cannot occur. Sloped roofs seldom leak even when openings are on the roof because there is no net force acting to move water inward. Overlapping the sheathings limits the direct entry of rain drops by impingement and gravity acts to move water outward down the slope, counteracting the air pressure difference that tends to drive moisture inward. As the slope of a roof is decreased, the resistance of gravity to inward flow becomes less and the inward air pressure is also reduced. Leakage through roofing sheets occurs when the height of rise provided by the slope and overlap is insufficient to produce a hydrostatic pressure greater than the inward air pressure drop. For leak proof construction, whatever the pitch of the roof, purlins should be straight and level. Sags and high points between and at the trusses will affect the efficiency of the side lap. Although high pitch roof may cost slightly more, the roof stability in a wind environment will compensate for the slight cost increase.

4.4.3 Remedies to Wood Decay

4.4.3.1 Moisture content regulation

Wood moisture content is considered the key environmental factor that must be either controlled or reckoned with in the design of durable wood structures that will be able to withstand biological attack. Preventive measures against fungi include the use of building designs that keep wood dry, use of preservative-treated wood, and the use of wood with natural decay resistance. The degree of wood decay will determine which options are exercised. The two principal, contemporary means for preventing subterranean termite attack are site sanitation and soil treatments. These measures are only prescribed where presence of these insects is confirmed.

Wood used or exposed under conditions where wood moisture content will be high requires protection with wood preservatives. The most likely way to prevent this problem seems to be through application of appropriate control procedures where the wood is harvested. Most protective measures taken against biological deterioration follow the principle of total exclusion or elimination of the likely pest.

4.4.3.2 Use of durable wood

Use of naturally durable woods was perhaps one of the earliest measures taken to prevent wood deterioration. Subsequent approaches include: modification of individual environmental parameters such as temperature or oxygen content to gain a measure of biocide control; treatment of wood products, structures, or the immediate environment with biocides; quarantines to keep pests from entering new areas; and designs to preclude an environment favorable for biological attack. The use of these wood species in roof construction will ameliorate cases of roof failures Omo (*Cordia millenii*), Afara (*Terminalia ivorensis*), Iroko (*Melicea exelsa*) Opepe (*Nauclea diderrichii*), Ayo (*Holoptalia grandis*) Agba (*Gossweilerodendron balsamiferum*) Erun (*Erythrophum suavecolens*), Apado (*conluea gradiflora*), Teak (*Tectona grandis*), Arere (*Triplochiton scleroxylon*), Apa (*Azelia Africana*), Oro (*Nasogoidonia papaverifera*). The mechanical properties of these species, their durability, availability and strength make them suitable roofing materials in the Zone. The use of solignum and creosote for the treatment of woods will add to the durability of roof structures.

4.4.3.3 Designing for Wood Decay Prevention

Two design details that can help to protect wooden structures from the infiltration of water, even if there are other structural deficiencies, are a substantial roof overhang and effective gutter systems. Both of these protect the vertical walls from excessive water exposure. The water-shedding capacity of the roofing material itself is also of prime importance because it is the first and most significant deterrent to wetting by rain- water. The roofing material itself may be decay-resistant or preservative treated wood, which has a number of favorable properties, but it is not without its hazards as well. Wooden roofs have finite service lives and should be subjected to careful periodic inspections. A wooden roof, which has begun to decay can no longer shed water and threatens the entire structure.

The strategy employed in protecting wooden roofs used in a wet environment from decay is to make the wood unavailable to fungi as a source of nutrients and energy. If wood can be poisoned or made undesirable as a source of food, fungal attack can be averted. Pressure treated lumber is the best choice to be used when wood is to be exposed to weather that encourage decay such as in southwestern Nigeria. In this case decay is prevented despite the presence of the required conditions for the survival of fungi that includes adequate supply of oxygen, favourable temperature (0°-32°C) and food. When selecting pressure treated material it is important to use the proper treatment for the job. The most common preservative used in treated wood is Chromated Copper Arsenate (CCA). The amount of preservative in the wood after treatment is called the retention level. Wood that will be exposed to fungi should have a 3.80Kg/m³ retention level. Woods with heartwood are fungi resistant. The heartwood is the darker centre section of cells that are no longer living, but provides mechanical support to the tree. The heartwood contains extractives, which are toxic to most decay fungi and some insects. The use of wood of high heartwood resistance to decay as roof construction materials will also save a lot of decay damages in the western part of Nigeria.

4.4.4 Rust Prevention

Metal roofing materials can be protected and reinforced in the following ways

4.4.4.1 Painting

The roofing materials can be prevented from corrosion by coating them with paint. Corroded material can be coated with paint to inhibit the further deterioration. Rust, however causes bubbles to form under paint work.

4.4.4.2 Polymer Coating

The introduction of colored polymers has provided longer lasting protection together with aesthetic appeal to metal roofing sheets.

4.4.4.3 Zincalume Coating

As the name suggests Zincalume is a mixture of Zinc and Aluminum, which makes a superior coating to the old fashion galvanizing of steel.

4.4.4.4 Anodizing

Aluminum can be made more resistant to corrosion by this process. The process increases the thickness of the oxide layer. It involves the electrolysis of sulphuric acid, using Aluminum as the anode. Oxygen is released at the anode during the electrolysis and reacts with the Aluminum and thickness the oxide layer.

4.4.4.5 Galvanizing

This is the coating of steel with Zinc, where Zinc acts as the sacrificial anode because it is more easily oxidized than iron, hence is sacrificially exposed to water and air. The sacrificial anode has to be replaced at regular intervals to maintain the protection.

4.4.5 Maintenance

In order to get the full use from any equipment, whether it is mechanical or structural, it is necessary to have an adequate maintenance program. Routine precautionary measures should be taken regularly from the time a structure is built. It could be an annual routine checks and repair be of roof members after rainy season of the year. One of the most important steps is to keep the roof or building area free of floating debris, as this is an excellent source of both borer and mechanical damage. All roofing members and materials must be partially or totally replaced after their service lives have passed when there are signs of distress or deterioration in any of them. Detecting the presence of decay in existing buildings and locating the sources of water infiltration are often very difficult tasks. The easiest and safest approach is to design and construct the building so as to prevent the entry of water into the wooden portions of the structure, this can be achieved with high pitched roof, the use of polythene laid on the purlin before putting sheathing materials and long eaves construction. .

4.4.6 Construction

4.4.6.1 Joints

Joints are inevitable in timber structure. This is because wood comes in specific sizes and dimensions in the market. In order to guide against failure, the correct joint must be used at various locations on the roof.

Many of the joint observed during the survey were ordinary butt joints such as those shown in Figure 4.15a that can not properly transfer load from one member to the other. It is therefore recommended that scarf joints with cover plates as shown in Figure 4.15b be used at joints. Figure 4.16a shows wrong joint construction as it has already created eccentricity in the arrangement of members, Figure 4.16b is therefore recommended. Similarly Figure 4.17b is recommended rather than Figure 4.17a.

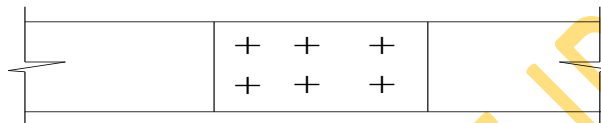

Figure 4.15a: Butt Joint

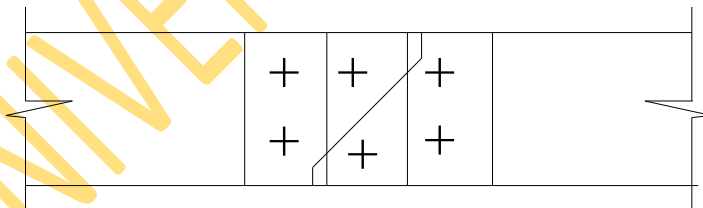

Figure 4.15b: Scarf Joint with Plate

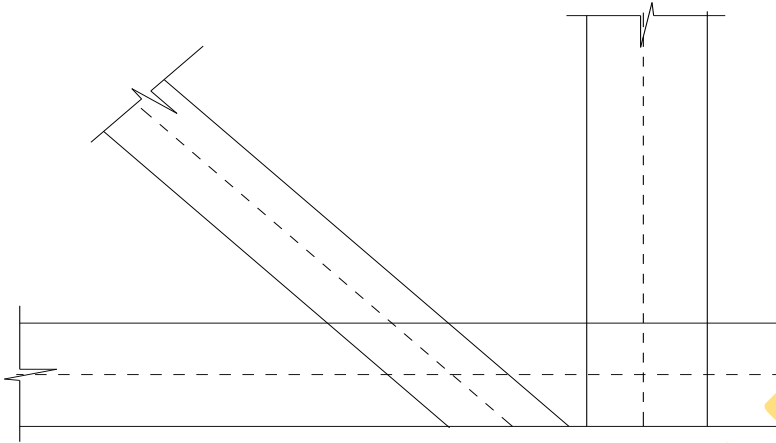

Figure 4.16a: Joint with eccentricity

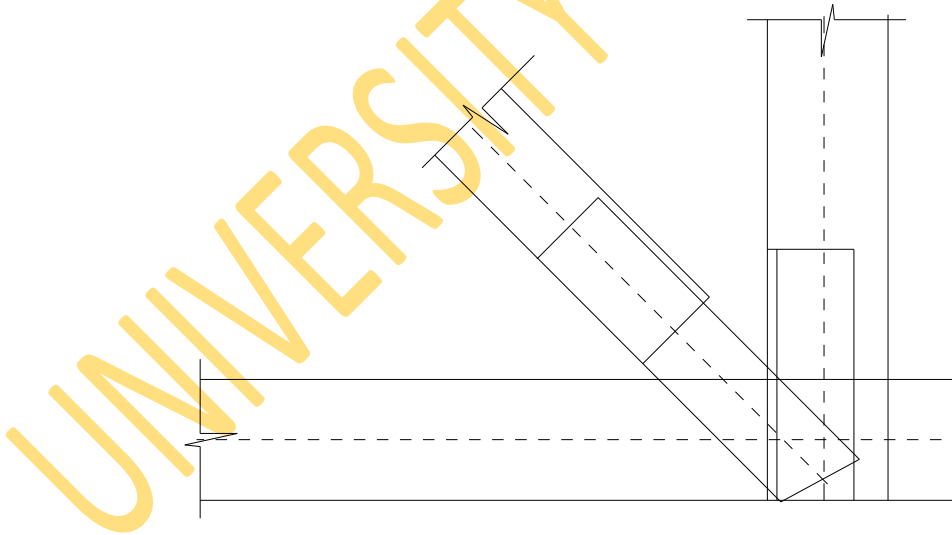

Figure 4.16b: Joint with no eccentricity

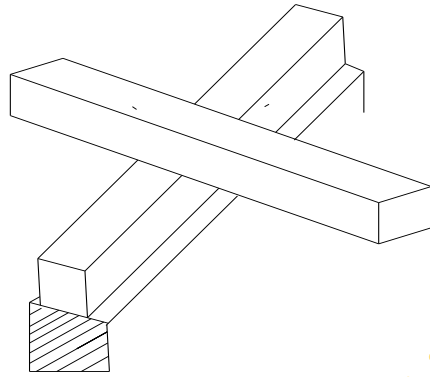

Figure 4.17a: Rafter with no wedge

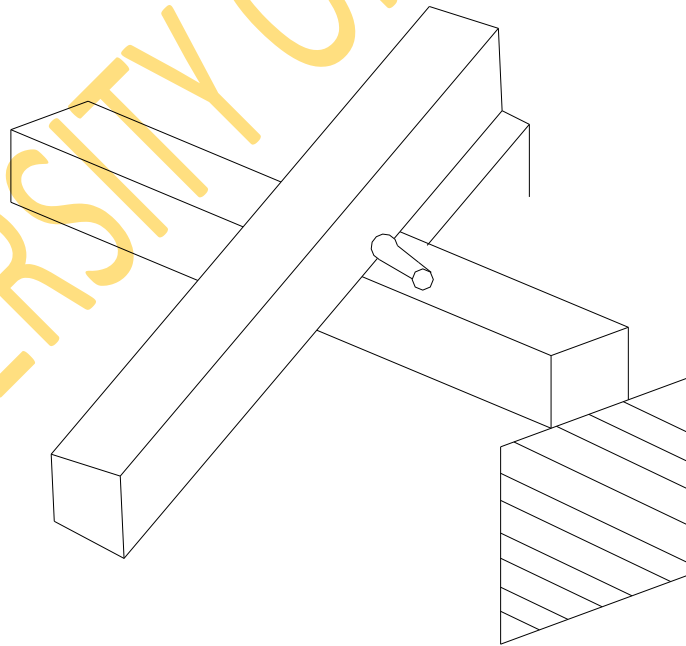

Figure 4.17b: Rafter with wedge

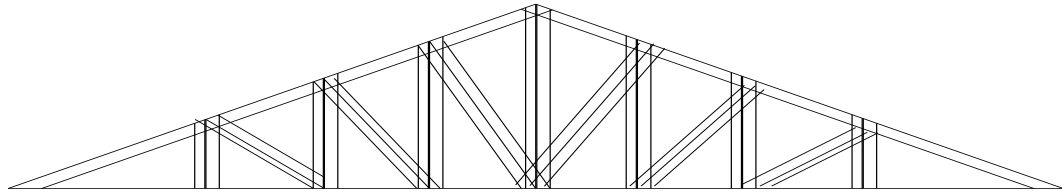

Fig 4.18a: Rafter with no wedge

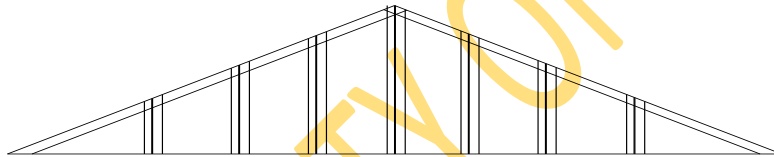

Figure 4.18b: Rafter with no webs

4.4.6.2 Installations

One of the errors in roof construction in Southwestern Nigeria is that rafter are just placed on the wall plates as shown in figure 4.18b rather than having web so as to prevent movement during nailing figure 4.18a. The above was observed in 1193 out of the 1894 failure cases representing 63% of the failures.

There should be sufficient webs in the trusses as shown in fig. 4.18a instead of few of them as observed during the study.

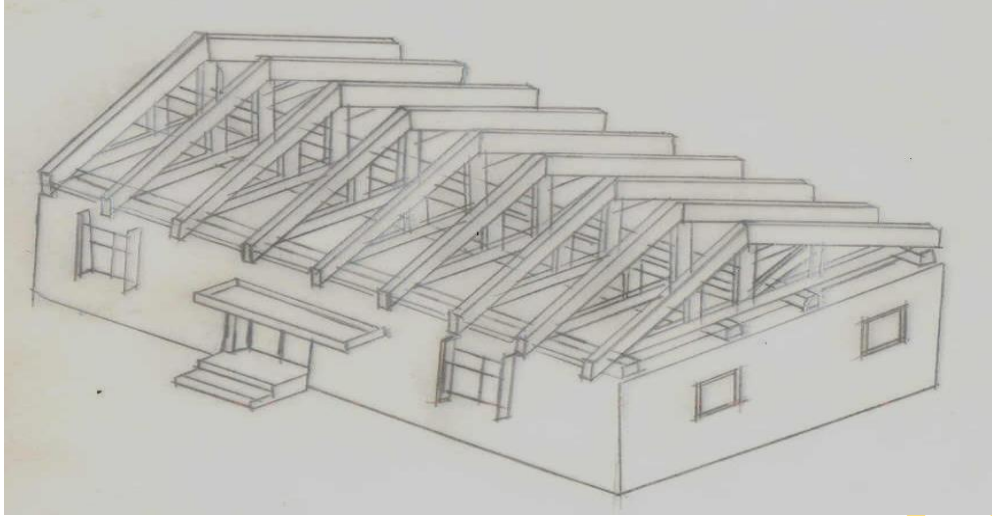

Fig. 4.19 Installation of Roof Rafters

To ensure good roof installation, the wall plates should be fixed on a perfectly leveled ranged wall (using range and plum) well anchored then the rafter wedged and fixed to the wall plate. There should be provision of wall plates on intermediate wall to reduce the span of the bottom chord. In preparing wood for roof trusses, it is better to plain the surfaces of the wood, most especially the topmost surfaces of the rafter and at least two surfaces of the purlins.

Fixing of the iron roofing sheet should be such that the groves are not across the main wind direction. This is because of orthotropic characteristics of iron sheets which has low resistance across the corrugation. The use of roof board while walking on the roof should be encouraged for the protection of the sheathing and for safety precaution.

4.4.7. Roof Overhang

Appropriately sized roof overhangs have two major benefits: They keep unwanted, hot summer sun from heating a home, and they help protect the home from moisture damage caused by precipitation. While protecting the walls and foundation from excess moisture, roof overhangs over entries and windows are also convenient for the occupant during foul weather. An overhang over an entry, such as a porch or even an eave, protects occupants from precipitation, but also protect the door's finish from moisture around jambs, trim, and thresholds, thereby minimizing the need for maintenance. Studies have shown that the larger the size of overhang for windows

or doors, the less frequently moisture penetration problems will occur on the exterior and foundation walls.

4.4.8 Drainage

Most walls used in building houses in the western part of Nigeria are absorbent media for water. Underground water within the foundation level, water on bathroom floors and water linking from poor conditioned drainage pipes are adsorbed and transported to the roof through walls and forming films of water on wooden roof thereby causing decay

Roof sagging is inevitable wherever there is wood decay, however there could be sagging without decay, sagging may occur as a result of under estimation of roof load during design whereas the spacing of trusses and purlins are seriously defective. Also sagging may occur where the roof span is extremely too large for the truss material to support. Detecting the presence of decay in existing buildings and locating the sources of water infiltration are often very difficult tasks. A wooden building protected from water and ground contact and properly maintained should, normally be durable barring some sort of catastrophe.

CONCLUSION AND RECOMMENDATIONS

5.1 Conclusion

The nature, characteristics and the inter-relationship between the various causal factors of roof failures in Southwestern Nigeria were studied. These factors are those of materials, design, construction technology, maintenance culture and the environmental influences on roof. The environmental factors considered include wind speed with its return period, orientation of roof to the wind direction and the topographical location of the building.

From the results of the study the following conclusions can be drawn

1. The type of failures to which roofs are subjected in order of severity included nail rust nail withdrawal, sheeting leakage and tearing, wood decay, sagging and damage of trusses, open lap, ponding, discolouration and total blown-off.
2. Roof failures are prominent in the zone due to the inadequacies of roof joints to withstand the load they are designed for, low pitched roofs, inadequate web, insufficient diagonal bracing of roof trusses and lack of maintenance.
3. Excessive flexibility and high heat fluctuation and exchange rate between the surrounding and the attic of the roof increase the tendency of roof failures.
4. Wind effect on a roof is most severe when the main span of the roof is oriented at 45^0 to the main wind direction.
5. There were no statistical differences between the roof blow-off model predictions and post model survey data
6. Optimum roof pitch slope for the zone that will enhance roof structural stability is 55^0 .
7. Wind speed at the summit of hill could be related to the wind speed at the plain by this relationship:

$$V_s^2 = 0.9984 \frac{h(h+2y)}{(h+y)^2} \left(\frac{(\sin\phi + \cos\phi)^9}{(\cos\phi + \sin\phi)} - \frac{(\sin\phi)^9}{\cos\phi} \right) \quad \text{Eqn. 5.1}$$

V_s is the speed along the slope (m/s^2)

V is the speed at the plain (m/s^2)

ϕ is the slope angle of the hill (degree)

y is the height above ground level (m)

5.2 Recommendations

1. There should be annual and proper maintenance programme for the roofs in the zone after each rainy season. The use of less quality roofing materials should be discouraged.
2. The research has reported that high pitched roof slope between 40° and 55° will enhance structural stability. Other researcher should be interested in investigating roof gutters that are adequate for which slope angle were not investigated.
3. The effect of housing arrangements on roof failures has not been considered and such need to be verified.
4. Also research work should be done on wood joint design and detailing.
5. Government should formulate policy that will ensure minimum standard for roof construction and that all roofs must be designed by a registered practicing structural Engineer.
6. The use of seasoned high quality wood, provision of courtyard for large roof and good anchorage if need be casing of the wall plate/ sill, provision of adequate openings well positioned in the roof and regular maintenance programme should be adopted in the zone.

REFERENCES

- Aasin, O.A.:2008 *Proposed Roofing System for the Tropics* Unpublished Lecture Material at the Department of Civil Engineering, Federal Polytechnic, Ede, Nigeria
- Adenekan, O.I.: 2000 'A Survey of Rainstorms as Weather Hazards in Southern-Nigeria', *Journal of the Environmentalist* Vol.20, No.33, pg 33-39
- Adeniran, A.E: 1997 Development of a Strategic Planning Model for the University of Ibadan Water Supply Treatment Plant; M.Sc. Project Report in the Department of Mechanical Engineering, University of Ibadan
- Adesogan, S.O.: 1997 *Wood Utilisation in Recent Building Projects in the University of Ibadan*, Seminar paper, Department of Agricultural Engineering, University of Ibadan
- Afolayan A. A 2002. "GEO 350- Africa" Hand out for Centre for External Studies University of Ibadan.
- American Standard for Testing Materials (ASTM) 1977: Standard Method for evaluating Accelerated Corrosion Test. ASTM D2915-74. Philadelphia, PA.
- American Standard for Testing Materials (ASTM) 1761: Standard Method for Testing of Wood Joint Strength. ASTM D245-74. Philadelphia, PA.
- American Standard for Testing Materials (ASTM) D 442: Standard Method for Moisture Contents Determination. ASTM D245-74. Philadelphia, PA.
- Anonymous: 1953 *Steel Pipes for Water, Gas, Sewage and Air*. Stewarts and Lloyds Limited, London
- Anonymous 2009 Metal Roofing Materials <http://www.mooioom.com> accessed (4th June 2009)
- Atlas Steels Australia: 2010. Atlas Technical Notes- Atlas Steels
http://www.atlas.steels.com.au/technical_info.html accessed (4th June 2009)
- Ayoade, J.O.: 1980 A Note on Spatial and Seasonal Variations in wind Speed over Nigeria
Singapore journal of Tropical Geography Pg 11-15

- Ayorinde, E.O. 2002 Building Construction, Vol.1, Abiola Bookshop Press Ltd., Ikeja
- Barry, R.: 1969. The Construction of Buildings, Granada, London
- Barry, R.: 1984. The Construction of Building, Vol.3, The English Language Book Society and Granada, London
- Blake, L.S.: 2001. Civil Engineer's Reference Book, Butterworth-Heinemann, Linacre House, Jordan Hill, Oxford Ox28Dp
- Brough, J.C.S.: 1964. Timbers for Woodwork, Evans Brothers Limited, Montague House
Russell Square, London W.C.1
- British Standard (BS 1162) 1977, Roofing felts
- Burleson, J.D.: 2005 "Hurricane Elements and Building Interaction" *Building Safety Journal* Vol. 12 No.3 Pg 30
- Canadian Building Digest (CBD70) 1965: Thermal Consideration in Roof Design. Journal of National Research Council Canada. Vol. 10.NO. 1 pg 45.
- Chalton, N.T., Collins, J.R., Peterson, J.G., Toner, R., and Huddleston, J.A.: 2002 "Sound Assembly", *Journal of ASCE* Vol. 70.NO. 1 pg 60
- Choiniere, S.: 2006 "Understand Wind Uplift Rating" <http://www.roofingcontractor.com/Articles>
- Chukwuneke, I.: 2000 "The Design and Construction of the 50,000 Seat Faith Tabernacle", *Journal of the Nigerian Institution of Structural Engineers* Vol.10 No.3 Pg 30-36
- Cook, N.J. and Mayne, J.R.: 1979 "A Novel Approach to the Assessment of Wind Loads for Equivalent Static design" *Journal of Wind Engineering and Industrial Aerodynamics* Vol. 4, Issue 2, Pg 149-164
- Cotz, V.J.: 2000 "Plant Engineers Practical Solution for Saving a Sagging Roof Structure", *Journal of Plant Engineering* Vol. 38 No. 5 Pg 10
- Dorfaman, R.: 1970 *Problems of Modelling Environmental Control System* Center for Management Science, Economics and Environmental Science; Wright- Allen Press New York

- Edwards, D. and Hamson, M.: 1992 *Guide to Mathematical Modelling*; The Macmillan Press Ltd. Houndmills, Basingstoke, Hampshire RG21 2XS
- Ezeji, S.C.: 2004 *Building Construction*, Longman group Ltd., London
- Findlay, W.P.K.: 1962 *Preservation of Timber*; Adams and Charles Black, London
- Forrester, J.W.: 1968. *Principles of Systems*; Wright- Allen Press New York.
- Fullerton, R.L. 2005 *Building Construction in Warm Climate*, Oxford University Press,
- Gniadzik, J.S.:1984 *Structural Systems in Architecture* Unpublished Lecture Material. At the Department of Architecture, Ahmadu Bello University, Zaria
- Gumel, E.J. 1958. *Statistics of Extremes*. Columbia University Press, New York
- Henry, L. 1977 “*A Birdseye View*”. *Progressive Architecture*, Oxford University Press
- Ivor, H.S.: 1981 *Building Technology*, The Macmillan Press Ltd., London
- Jakkula, A.A. and Stephenson, H.K.: 1953 *Fundamentals of Structural Analysis*: D Van Nostrand Company (Canada), Ltd
- Koenigsberger, O.H.; Ingersoll, T.G.; Mayhew, A. and Szokolay, S.V.: 1974 *Manual of Tropical Housing and Building: part 1 Climatic Design*: Longman Group Limited London
- Kumar, K.S. and Stathopoulos, T.: 2000 ‘Wind Loads on Building Roofs’, *Journal of Structural Engineering ASCE* Vol. 126 No8 pg38
- Labine, R.A.C.: 1975 “Repairing Slate Roofs” *The Old House Journal*, Vol.3 No 12 pg 67
- Longman, K.A and Jenik, J.: 1987 *Tropical Forest and its Environment* John Wiley and Sons New York
- Malcom, H.: 1991 *Surveying Buildings*, R.I.C.S. Books, England
- McKay, W.B.: 1969 *Building Construction*, Vol.3, Longman Green and Company Ltd., London
- Metthem, C.J.: 1986. *Structural Timber Design Technology*, Timber Research and Development Association, Longman Group, U.K Ltd., Essex, England

- Minjinyawa, Y.: 2010 *Farm Structures* 2nd edition, University Press, University of Ibadan, Ibadan, Nigeria
- Murphy, N.P., Page, N. W. and Rodin, E.Y.: 1990 *Introduction to Mathematical Modelling*, Pergamon press Canada Ltd., Suite No 271, 253 College street, Toronto Ontario Canada M5T 1R5
- Nigerian Code of Practice (NCP), 1973: *Imposed Loads on Building for Various Conditions*.
- Norman, E.H.; 1967 *The Conservation of Building Timbers*, Hutchison and Co. Ltd., Nostrand Company (Canada), Ltd
- Olomola S.A. 2002 'Housing Today', *The Journal of the Association of Housing_Corporation of Nigeria*, Vol. 14, No. 23, pp 38 to 39
- Owen, R.E.: 1972 *Roofs*, Macmillan, London
- Owen, R.E.: 1985 *Roofs*, Macmillan Publishers Ltd., Houndmills, Basingstoke, London.
- Oxley, P.J and Posket, L.: 1977 *The Supply of Building Materials in Sudan* Pergamon Press, Britain.
- Oyebode, O.J. 2006: *Survey of Rural Housing Conditions in Osun State*. Unpublished Msc Thesis, Obafemi Awolowo University, Ile-Ife.
- Panshin, A.J. and Carl de Zeeuw.: 1980 *Textbook on Wood Technology* McGraw-Hill Book Company, New york
- Paton, J.: 2000 *American Heritage Dictionary of the English Language*, Houghton Mifflin Harcourt Publishing Company, Boston Massachusetts
- Paulhus, J.L.: Kohler, M.A. and Linsley, R. K.: 1958 *Hydrology for Engineers* McGraw-Hill Book Company, London
- Peronian, C.A.: 1962 '*Designing for Hurricanes*' *Mechanical Engineering*, Vol. 84, No 9 pg 44
- Pettit, Tom: 1980 *Wood work made Simple* W.H. Allen and Company Ltd., 44 Hill Street, London W1X 8LB

Roskind, T. E.: 2009 *Roof, Definition, Synonyms from Answers.com*,
<http://www.answers.com/topic/roof>

Scott, C.: 2009 *Trusses* <http://www.bultrading.co.za> accessed (July 19th, 2009).

Seeley, I.H.: 1974 *Building Technology*, Macmillan, London

Stanford, J.H. and R de Neufville.: 1971 *Systems Analysis for Engineers and Managers*
 Mcgraw-Hill New-York.

The World Book Encyclopaedia, (1995). *Hip roof*. <http://www.yourdictionary.com/roof>.

Tom, D.L.: 2009 Preventive Roof Maintenance. www.feapc.com/ accessed (24th August 2010)

Ulam, S and Metropolis, N.: 1949 “The Monte Carlo Method”. *Journal of American Statistical Association*, Vol. 44 No 27

Vila, B. 2007 *The Roofing Process* <http://www.bobvila.com/channels>

Walton, D.W.: 2001 *A Building Project for Diploma Students*, Macmillan Publishers Ltd.,
 London

Walton, J.A.: 1974 *Wood work in Theory and Practice*, NCCP, Sydney, Australia

Warland, D.E.: 2000 *Construction Processes and Materials*, Hodder and Stoughton Ltd., London

Watkins, D.L.: 2005 *Preventive Roof Maintenance*. www.feapc.com

Watson, K.: 2009 *Roof Failure: Effects and Causes* Trade Press Company, Hollywood

Works and Maintenance Department, U.I 2007

Works and Maintenance Department, Bowen University Iwo 2008

World Health Organization (WHO) 2005 Habitat for Better urban Future.
<http://www.cin.gov.cn/Habitat/en/brief01.htm>

Zakopane, K.: 2010 *Technical monument of Poland*
http://www.sulinet.hu/oroksegtar/data/kulturalis_ertekek_a_vilagban/Visegrad_orszagok_tech_nikai_2/pages/angol/004_lengyelo_muszaki_muemlekei.htm accessed (4th June 2010)

APPENDIX 1: QUESTIONNAIRE

INCIDENCES OF ROOF FAILURE IN SOUTH-WESTERN NIGERIA: CAUSES AND SUGGESTED PREVENTIVE MEASURES

A. DEMOGRAPHIC

1. Location of building
2. Topography: uphill, valley, plain
3. Site layout: virgin, built up
4. Structure of environment: planned, un-planned
5. Building orientation/ alignment of building frontage
6. building type: Bungalow, storey building
7. Distance to next building
8. Any wind breaker
9. Age of building/ and roof
10. Functional purpose

B. PLANNING

11. Does the roof have structural/ engineering detail?
12. Who does the specification of materials?
13. Was detailing of the roof done at the conceptualisation of the building/
14. If no to 13, when was it done?
15. Was wood specie considered during design or general assumption made?
16. What was the constraint in the choice of roofing materials
17. What was the expected life span?
18. What was the design function of the roof?
19. What critical state was considered? What other limit states were considered?
20. What is the roof slope?
21. What is the attic volume?
22. What is the eave width?
23. What is the truss type?
24. What is the effective span?
25. Are the joints properly detailed?
26. Was fatigue loading considered?

C. MATERIALS

27. What is the state of the sheathing materials?
28. How long have the materials stayed in the store before purchase?
29. Are the truss members of constant cross sectional area?
30. Any noticeable defects in materials?
31. What types of truss members are used?
32. What are the jointing materials and size?
33. What material is the wall plate made up?

D. CONSTRUCTION

34. Who supervises the construction?
35. How was the wall/sill plate attached to the wall?
36. What is the nailing adequacies in
 - Rafter/wall plate?
 - Rafter/purlin?
 - Purlin/sheathing materials?
37. What are the lap lengths in
 - Covering materials?
 - Rafters?
 - purlins
38. Do joints coincide with supports?
39. What is the bearing length of the tie beam?
40. Are roof members on straight lines?

E. MAINTENANCE HISTORY

41. How often do you have routine maintenance check on the roof?
42. Who does the maintenance check?
43. Do you notice any failure sign before now?
44. Is the roof failure gradual or sudden?
45. Any foreign materials on roof sheathing?
46. Has there been any history/record of failure on the roof/
47. What is the number of roofs affected by failure in this locality?
48. What is your general comment/remark?

APPENDIX 2: CLIMATIC DATA

Table1. Maximum Annual Wind Speed at Ado Ekiti

Date (1)	Max. Gust (Km/hr) (2)	Rank (3) R	Frequency (4) F	Reduced Variate y
31.05. 2006	23.50	1	0.024	-1.32
31.05. 2003	24.63	2	0.048	-1.11
31.10. 2003	25.15	3	0.073	-0.96
31.07. 2005	27.79	4	0.098	-0.84
31.01. 2003	28.00	5	0.122	-0.74
31.03. 2006	28.37	6	0.146	-0.65
30.06. 2003	28.83	7	0.171	-0.57
31.01. 2006	28.95	8	0.195	-0.49
30.04. 2006	30.06	9	0.220	-0.41
31.08. 2005	30.68	10	0.244	-0.34
28.02. 2006	31.12	11	0.268	-0.28
28.02. 2005	31.38	12	0.293	-0.21
31.01. 2002	31.67	13	0.317	-0.14
31.07. 2006	32.07	14	0.341	-0.07
28.02. 2003	33.17	15	0.366	-0.01
31.05. 2002	34.24	16	0.390	0.06
31.03. 2003	34.66	17	0.415	0.13
30.09. 2002	36.24	18	0.439	0.19
30.04. 2003	37.64	19	0.463	0.26
30.06. 2002	41.07	20	0.488	0.33
30.09. 2003	41.98	21	0.512	0.40
31.07. 2003	46.17	22	0.537	0.48
30.11. 2006	46.74	23	0.561	0.55
31.12. 2006	47.87	24	0.585	0.62
31.03. 2002	48.43	25	0.610	0.70
30.06. 2004	52.51	26	0.634	0.79
30.04. 2002	52.76	27	0.659	0.87
31.10. 2004	52.96	28	0.683	0.96

Table1 Continued

Date (1)	Max. Gust (Km/hr) (2)	Rank (3) R	Frequency (4) F	Reduced Variate y
28.02. 2002	54.12	29	0.707	1.06
31.05. 2004	54.80	30	0.732	1.16
31.10. 2006	61.68	31	0.756	1.27
31.08. 2003	62.33	32	0.780	1.39
30.09. 2004	66.29	33	0.805	1.53
30.09. 2006	69.81	34	0.829	1.67
30.04. 2004	75.22	35	0.854	1.85
31.07. 2002	78.81	36	0.878	2.04
31.07. 2004	81.30	37	0.902	2.27
31.07. 2004	85.29	38	0.927	2.58
31.08. 2006	89.90	39	0.951	2.99
31.08. 2002	91.67	40	0.976	3.72

Table 2 Maximum Annual Wind Speed at Akure

Month (1)	Max. Gust (Km/hr) (2)	Rank (3) R	Frequency (4) f	Reduced Variate y
31.10. 2003	26.83	1	0.024	-1.32
31.12. 2004	27.21	2	0.048	-1.11
31.03. 2005	27.61	3	0.073	-0.96
31.01. 2003	29.12	4	0.098	-0.84
30.06. 2003	30.00	5	0.122	-0.74
13.07. 2005	30.18	6	0.146	-0.65
31.01. 2006	30.27	7	0.171	-0.57
30.04. 2006	30.67	8	0.195	-0.49
31.08. 2005	31.25	9	0.220	-0.41
28.02. 2006	31.54	10	0.244	-0.34
28.02. 2005	31.81	11	0.268	-0.28
31.07. 2006	32.10	12	0.293	-0.21
28.02. 2003	33.63	13	0.317	-0.14
31.01. 2002	33.74	14	0.341	-0.07
31.03. 2006	33.99	15	0.366	-0.01
31.05. 2002	37.05	16	0.390	0.06
30.09. 2002	37.83	17	0.415	0.13
30.04. 2003	38.41	18	0.439	0.19
31.03. 2003	41.53	19	0.463	0.26
30.06. 2002	42.72	20	0.488	0.33
30.06. 2003	43.76	21	0.512	0.40
31.07. 2003	46.21	22	0.537	0.48
30.11. 2006	48.28	23	0.561	0.55
30.04. 2002	53.83	24	0.585	0.62
30.06. 2004	54.63	25	0.610	0.70
28.02. 2002	54.86	26	0.634	0.79
31.10. 2004	56.50	27	0.659	0.87
31.12. 2006	56.85	28	0.683	0.96
31.03. 2002	58.03	29	0.707	1.06
31.05. 2004	59.30	30	0.732	1.16

Table 2 Continued

Month (1)	Max. Gust (Km/hr) (2)	Rank (3) R	Frequency (4) f	Reduced Variate y
31.08. 2003	64.50	31	0.756	1.27
31.10. 2006	65.80	32	0.780	1.39
30.09. 2004	69.29	33	0.805	1.53
30.09. 2006	73.00	34	0.829	1.67
30.04. 2004	76.61	35	0.854	1.85
31.07. 2002	78.88	36	0.878	2.04
31.08. 2004	82.82	37	0.902	2.27
31.07. 2004	85.36	38	0.927	2.58
31.08. 2006	91.48	39	0.951	2.99
31.08. 2002	93.38	40	0.976	3.72

Table 3: Maximum Annual Wind Speed at Old Air port, Ibadan

Month (1)	Max. Gust (Km/hr) (2)	Rank (3) R	Frequency (4) f	Reduced Variate y
31.10. 2003	29.55	1	0.024	-1.32
31.01. 2003	29.74	2	0.048	-1.11
31.03. 2005	30.47	3	0.073	-0.96
30.06. 2003	30.91	4	0.098	-0.84
31.01. 2006	30.92	5	0.122	-0.74
30.04. 2006	31.68	6	0.146	-0.65
31.08. 2005	31.88	7	0.171	-0.57
31.07. 2005	32.20	8	0.195	-0.49
31.12. 2004	33.39	9	0.220	-0.41
31.01. 2002	33.62	10	0.244	-0.34
28.02. 2006	34.41	11	0.268	-0.28
28.02. 2005	37.71	12	0.293	-0.21
31.07. 2006	35.65	13	0.317	-0.14
28.02. 2003	36.69	14	0.341	-0.07
31.03. 2006	37.51	15	0.366	-0.01
31.05. 2002	38.30	16	0.390	0.06
30.09. 2002	39.14	17	0.415	0.13
30.04. 2003	39.69	18	0.439	0.19
30.06. 2002	44.03	19	0.463	0.26
30.09. 2003	45.27	20	0.488	0.33
31.03. 2003	45.83	21	0.512	0.40
31.07. 2003	49.60	22	0.537	0.48
30.04. 2002	55.62	23	0.561	0.55
30.06. 2004	55.77	24	0.585	0.62
30.11. 2006	57.71	25	0.610	0.70
28.02. 2002	59.85	26	0.634	0.79

Table 3 Continued

Month (1)	Max. Gust (Km/hr) (2)	Rank (3) R	Frequency (4) f	Reduced Variate y
31.05. 2004	61.30	27	0.659	0.87
31.10. 2004	62.21	28	0.683	0.96
31.03. 2002	64.03	29	0.707	1.06
31.08. 2003	64.77	30	0.732	1.16
31.12. 2006	69.77	31	0.756	1.27
30.09. 2004	69.95	32	0.780	1.39
31.10. 2006	72.49	33	0.805	1.53
30.09. 2006	73.70	34	0.829	1.67
30.04. 2004	79.23	35	0.854	1.85
31.08. 2004	84.49	36	0.878	2.04
31.07. 2002	84.67	37	0.902	2.27
31.07. 2004	91.63	38	0.927	2.58
31.08. 2006	93.31	39	0.951	2.99
31.08. 2002	95.25	40	0.976	3.72

Table 4: Maximum Annual Wind Speed at New Air port, Ibadan

Month (1)	Max. Gust (Km/hr) (2)	Rank (3) R	Frequency (4) f	Reduced Variate y
30.06. 2003	32.24	1	0.024	-1.32
31.07. 2005	32.44	2	0.048	-1.11
31.08. 2005	32.60	3	0.073	-0.96
31.03. 2005	32.73	4	0.098	-0.84
30.04. 2006	33.00	5	0.122	-0.74
31.10. 2003	33.06	6	0.146	-0.65
28.02. 2006	35.06	7	0.171	-0.57
28.02. 2005	35.37	8	0.195	-0.49
31.07. 2006	35.91	9	0.220	-0.41
31.01 2003	36.26	10	0.244	-0.34
28.02. 2003	37.39	11	0.268	-0.28
31.01. 2006	37.69	12	0.293	-0.21
31.03. 2006	40.28	13	0.317	-0.14
30.09. 2002	40.55	14	0.341	-0.07
30.04. 2003	41.34	15	0.366	-0.01
31.05. 2002	41.51	16	0.390	0.06
31.01. 2002	42.00	17	0.415	0.13
31.12. 2004	42.68	18	0.439	0.19
31.05. 2006	45.81	19	0.463	0.26
30.06. 2002	45.92	20	0.488	0.33
30.09. 2003	46.90	21	0.512	0.40
31.03. 2003	49.23	22	0.537	0.48
31.07. 2003	51.70	23	0.561	0.55
30.04. 2002	57.94	24	0.585	0.62
30.06. 2004	58.71	25	0.610	0.70
28.02. 2002	60.98	26	0.634	0.79
31.08. 2003	66.23	27	0.659	0.87
31.05.2004	66.43	28	0.683	0.96

Table 4 Continued

Month (1)	Max. Gust (Km/hr) (2)	Rank (3) R	Frequency (4) f	Reduced Variate y
31.03. 2002	68.77	29	0.707	1.06
31.10. 2004	69.70	30	0.732	1.16
30.11. 2006	70.86	31	0.756	1.27
30.09. 2004	74.25	32	0.780	1.39
31.10. 2006	75.54	33	0.805	1.53
30.09. 2006	78.23	34	0.829	1.67
30.04. 2004	82.46	35	0.854	1.85
31.08. 2004	86.40	36	0.878	2.04
31.07. 2002	88.24	37	0.902	2.27
31.08. 2006	95.43	38	0.927	2.58
31.07. 2004	95.50	39	0.951	2.99
31.08. 2002	97.40	40	0.976	3.72

Table 5: Maximum Annual Wind Speed at Iwo

Month (1)	Max. Gust (Km/hr) (2)	Rank (3) R	Frequency (4) f	Reduced Variate y
30.06. 2003	34.24	1	0.024	-1.32
31.12. 2002	34.79	2	0.048	-1.11
28.02. 2006	35.06	3	0.073	-0.96
28.02. 2005	35.37	4	0.098	-0.84
31.07. 2006	36.06	5	0.122	-0.74
31.10. 2003	36.49	6	0.146	-0.65
31.03. 2004	36.74	7	0.171	-0.57
31.01. 2003	36.96	8	0.195	-0.49
28.02. 2003	37.39	9	0.220	-0.41
31.03. 2005	38.30	10	0.244	-0.34
31.01. 2006	38.42	11	0.268	-0.28
30.11. 2004	38.42	12	0.293	-0.21
30.09. 2002	40.55	13	0.317	-0.14
31.05. 2002	42.22	14	0.341	-0.07
30.04. 2003	42.81	15	0.366	-0.01
31.01. 2002	42.82	16	0.390	0.06
30.09. 2003	46.90	17	0.415	0.13
31.03. 2006	47.14	18	0.439	0.19
30.06. 2002	48.77	19	0.463	0.26
31.07. 2003	51.92	20	0.488	0.33
31.12. 2004	54.91	21	0.512	0.40
31.03. 2003	57.61	22	0.537	0.48
30.04. 2002	60.00	23	0.561	0.55
28.02. 2002	60.98	24	0.585	0.62

Table 5 Continued

Month (1)	Max. Gust (Km/hr) (2)	Rank (3) R	Frequency (4) f	Reduced Variate y
31.12. 2006	61.15	25	0.610	0.70
30.06. 2004	62.35	26	0.634	0.79
31.05. 2004	67.57	27	0.659	0.87
31.08. 2003	67.92	28	0.683	0.96
30.11. 2006	68.35	29	0.707	1.06
30.09. 2004	74.25	30	0.732	1.16
31.10. 2004	76.84	31	0.756	1.27
30.09. 2006	78.23	32	0.780	1.39
31.03. 2002	80.49	33	0.805	1.53
30.04. 2004	85.39	34	0.829	1.67
31.08. 2004	88.60	35	0.854	1.85
31.07. 2002	88.63	36	0.878	2.04
31.10. 2006	89.51	37	0.902	2.27
31.07. 2004	95.91	38	0.927	2.58
31.08. 2006	97.86	39	0.951	2.99
31.08. 2002	99.88	40	0.976	3.72

Table 6: Maximum Annual Wind Speed at Oshogbo

Month (1)	Max. Gust (Km/hr) (2)	Rank (3) R	Frequency (4) f	Reduced Variate y
31.07. 2006	36.31	1	0.024	-1.32
28.02. 2006	37.23	2	0.048	-1.11
28.02. 2005	37.55	3	0.073	-0.96
31.10. 2003	39.26	4	0.098	-0.84
28.02. 2003	39.69	5	0.122	-0.74
31.12. 2002	40.13	6	0.146	-0.65
30.06. 2003	41.69	7	0.171	-0.57
30.06. 2003	43.14	8	0.195	-0.49
30.09. 2002	43.16	9	0.220	-0.41
31.05. 2002	43.54	10	0.244	-0.34
31.03. 2004	45.31	11	0.268	-0.28
31.03. 2005	47.24	12	0.293	-0.21
30.11. 2004	49.40	13	0.317	-0.14
30.09. 2003	49.92	14	0.341	-0.07
31.07. 2003	52.30	15	0.366	-0.01
31.01. 2003	55.13	16	0.390	0.06
31.01 2006	57.31	17	0.415	0.13
31.03. 2006	58.25	18	0.439	0.19
30.06. 2002	59.39	19	0.463	0.26
30.04. 2002	60.47	20	0.488	0.33
30.11. 2006	62.23	21	0.512	0.40
31.12. 2004	63.32	22	0.537	0.48
31.01. 2002	63.87	23	0.561	0.55
28.02. 2002	64.75	24	0.585	0.62

Table 6

Continued.

31.12. 2006	68.25	25	0.610	0.70
31.05. 2004	69.69	26	0.634	0.79
31.08. 2003	69.70	27	0.659	0.87
31.03. 2003	71.05	28	0.683	0.96
30.06. 2004	75.93	29	0.707	1.06
30.09. 2004	79.02	30	0.732	1.16
31.10. 2004	82.66	31	0.756	1.27
30.09. 2006	83.25	32	0.780	1.39
30.04. 2004	86.20	33	0.805	1.53
31.07. 2002	89.28	34	0.829	1.67
31.08. 2004	90.91	35	0.854	1.85
31.10. 2006	96.30	36	0.878	2.04
31.07. 2004	96.57	37	0.902	2.27
31.03. 2002	99.27	38	0.927	2.58
31.08. 2006	100.41	39	0.951	2.99
31.08. 2002	102.50	40	0.976	3.72

Table 7: Maximum Annual Wind Speed at Ikeja

Month (1)	Max. Gust (Km/hr) (2)	Rank (3) R	Frequency (4) F	Reduced Variate y
31.07. 2006	42.53	1	0.024	-1.32
30.06. 2003	43.17	2	0.048	-1.11
31.05. 2002	44.34	3	0.073	-0.96
30.04. 2003	44.59	4	0.098	-0.84
30.11. 2002	44.99	5	0.122	-0.74
31.08. 2005	45.94	6	0.146	-0.65
30.11. 2003	46.02	7	0.171	-0.57
31.03. 2004	48.73	8	0.195	-0.49
31.03. 2005	50.81	9	0.220	-0.41
31.10. 2003	51.07	10	0.244	-0.34
31.10. 2004	54.03	11	0.268	-0.28
30.09. 2002	56.56	12	0.293	-0.21
31.12. 2006	60.29	13	0.317	-0.14
31.07. 2003	61.23	14	0.341	-0.07
30.06. 2002	62.26	15	0.366	-0.01
30.04. 2002	62.50	16	0.390	0.06
31.03. 2006	62.54	17	0.415	0.13
30.09. 2003	65.44	18	0.439	0.19
28.02. 2002	69.07	19	0.463	0.26
31.05. 2004	70.96	20	0.488	0.33
31.10. 2006	71.77	21	0.512	0.40
30.11. 2004	72.14	22	0.537	0.48
31.12. 2004	74.96	23	0.561	0.55
30.09. 2006	75.90	24	0.585	0.62
31.01. 2003	76.02	25	0.610	0.70
31.03. 2003	76.42	26	0.634	0.79

Table 7 Continued

30.06. 2004	78.63	27	0.659	0.87
31.01. 2006	79.03	28	0.683	0.96
31.12. 2002	82.56	29	0.707	1.06
30.11. 2006	86.95	30	0.732	1.16
31.01. 2002	88.08	31	0.756	1.27
30.04. 2004	89.09	32	0.780	1.39
31.08. 2003	94.06	33	0.805	1.53
31.07. 2002	101.78	34	0.829	1.67
30.09. 2004	102.41	35	0.854	1.85
31.03. 2002	106.76	36	0.878	2.04
31.07. 2004	113.11	37	0.902	2.27
31.08. 2004	121.30	38	0.927	2.58
31.08. 2006	134.46	39	0.951	2.99
31.08. 2002	136.75	40	0.976	3.72

Table 8: Maximum Annual Wind Speed in Western Nigeria

Month (1)	Max. Gust (Km/hr) (2)	Rank (3) R	Frequency (4) F	Reduced Variate y
31.07. 2002	78.81	1	0.024	-1.32
31.07. 2002	78.88	2	0.048	-1.11
31.07. 2004	81.30	3	0.073	-0.96
31.08. 2004	82.82	4	0.098	-0.84
31.08. 2004	84.49	5	0.122	-0.74
31.07. 2002	84.67	6	0.146	-0.65
31.07. 2004	85.29	7	0.171	-0.57
31.07. 2004	85.36	8	0.195	-0.49
31.08. 2004	86.40	9	0.220	-0.41
31.07. 2002	88.24	10	0.244	-0.34
31.07. 2002	88.63	11	0.268	-0.28
31.10. 2006	89.51	12	0.293	-0.21
31.08. 2006	89.90	13	0.317	-0.14
31.08. 2006	91.48	14	0.341	-0.07
31.07. 2004	91.63	15	0.366	-0.01
31.08. 2002	91.67	16	0.390	0.06
31.08. 2006	93.31	17	0.415	0.13
31.08. 2002	93.38	18	0.439	0.19
31.08. 2002	95.25	19	0.463	0.26
31.08. 2006	95.43	20	0.488	0.33
31.07. 2004	95.50	21	0.512	0.40
31.07. 2004	95.91	22	0.537	0.48
31.10. 2006	96.30	23	0.561	0.55

Table 8 Continued

31.07. 2004	96.57	24	0.585	0.62
31.08. 2002	97.40	25	0.610	0.70
31.08. 2006	97.86	26	0.634	0.79
31.03. 2002	99.27	27	0.659	0.87
31.08. 2002	99.88	28	0.683	0.96
31.08. 2006	100.41	29	0.707	1.06
31.08. 2002	102.50	30	0.732	1.16
30.09. 2006	103.39	31	0.756	1.27
31.03. 2002	103.77	32	0.780	1.39
31.03. 2002	106.76	33	0.805	1.53
31.08. 2006	107.87	34	0.829	1.67
31.07. 2004	108.96	35	0.854	1.85
31.08. 2002	110.10	36	0.878	2.04
31.07. 2004	113.11	37	0.902	2.27
31.08. 2004	121.30	38	0.927	2.58
31.08. 2006	134.46	39	0.951	2.99
31.08. 2002	136.75	40	0.976	3.72

Appendix 3: Daily Wind Run (Km/Hr)

	Jan	Feb	Mar	Apr	May	Jun	Jul	Aug	Sep	Oct	Nov	Dec
1	58.34	38.23	30.73	45.87	55.86	20.05	22.57	37.20	55.44	234.15	64.01	63.64
2	55.44	35.80	46.84	58.41	30.38	18.02	45.15	88.05	51.86	180.00	108.89	108.29
3	51.86	28.92	29.71	28.33	56.42	31.12	53.29	128.85	141.87	117.49	91.97	91.19
4	4.61	11.12	25.88	36.06	39.31	18.38	36.81	93.05	96.28	167.31	69.90	68.96
5	2.39	8.69	17.36	6.43	44.17	18.23	44.61	87.81	107.94	228.98	58.12	57.37
6	0.85	20.02	16.81	25.54	28.00	17.73	40.49	178.38	89.66	21.20	16.92	36.10
7	0.85	10.52	22.99	16.59	41.96	26.04	67.12	201.62	34.83	107.90	33.11	32.87
8	2.56	42.68	41.99	17.09	32.86	29.12	67.26	121.09	41.38	69.51	28.69	28.69
9	14.49	30.14	23.77	46.39	20.85	41.67	67.41	171.59	46.07	136.77	21.34	21.28
10	6.82	55.22	20.56	65.89	16.84	33.05	76.58	66.12	139.05	62.00	02.94	03.23
11	3.58	65.54	11.42	61.69	35.04	26.74	67.87	109.03	72.14	93.04	16.19	15.96
12	1.19	31.96	21.89	63.88	44.76	21.86	47.07	117.00	104.77	84.36	41.94	41.42
13	7.51	4.65	19.55	55.59	48.44	29.51	79.50	122.03	82.15	61.58	89.03	88.15
14	18.08	48.55	13.84	24.29	24.82	17.82	52.85	142.78	64.97	26.70	44.88	44.64
15	26.95	59.27	20.02	50.77	39.92	21.41	49.95	71.63	44.83	30.54	09.56	09.50
16	15.18	44.29	23.22	10.61	30.09	23.66	61.14	162.86	164.91	125.34	11.04	10.64
17	14.67	60.07	30.02	50.08	85.53	28.35	55.25	251.32	193.26	69.51	11.04	10.64
18	70.45	64.93	41.59	59.78	39.57	11.55	52.41	165.35	132.98	38.89	38.26	38.19
19	125.55	73.02	31.12	66.54	33.98	44.12	50.34	135.477	114.21	77.36	23.54	23.37
20	147.72	69.58	36.12	9.86	49.58	21.63	57.41	65.45	53.66	18.78	13.98	13.86
21	36.16	42.27	70.76	3.35	42.65	07.40	61.09	176.06	146.22	56.33	21.34	21.28
22	44.52	74.23	52.47	29.03	56.89	15.16	55.40	101.48	87.52	46.15	167.75	18.24
23	47.08	26.09	54.03	43.16	23.58	20.62	27.65	103.53	142.43	4.92	23.54	23.37
24	107.12	22.05	88.12	56.65	54.17	26.15	44.90	122.03	49.59	48.90	40.47	40.28
25	23.37	18.00	108.68	64.39	29.05	17.98	29.37	174.25	57.11	45.90	132.44	131.65
26	45.89	48.14	113.61	39.09	33.91	29.84	35.64	187.68	20.42	41.98	16.92	16.91
27	57.66	48.55	64.74	57.25	30.94	04.54	34.07	158.50	124.98	46.32	18.39	18.05
28	40.26	66.75	75.29	55.56	34.36	09.33	25.05	116.56	65.24	24.03	249.42	247.35
29	44.69		46.37	41.32	0.180	24.73	39.32	182.91	145.53	26.71	216.32	214.30
30	33.09		116.89	47.33	7.18	41.41	36.77	171.06	155.60	10.93	262.52	329.14
31	71.81		70.35		6.91		32.51	151.21		20.95		329.14

APPENDIX 4

DETERMINATION OF MOISTURE CONTENTS OF SOME WOOD SPECIES BEFORE CONSTRUCTION AND IN USE

Experiments were carried out to determine the moisture contents of some available wood species that are usually used for roofing as purchased from saw-mill and the final moisture content of wood in use in the roof.

Specimens: **Mansonia, Ayin, Gmelina, Omoo, Oroo, Teak and**
a wood specimen currently in use

Method: **The Oven-dry Method**

Apparatus: **Oven, Weight scale and Saw**

Moisture Content Measurement

The primary consideration in operating a kiln and delivering a stable product is the moisture content of the wood. Moisture-based schedules rely on the accurate determination of the moisture content of the lumber for advancement of drying conditions. Producers and consumers rely on the accurate determination of the final moisture content to ensure a stable product. One of the easiest to use and most recognized standards for determining the moisture content of wood is the oven-dry method. The oven-dry method is applicable to a very wide range of moisture contents i.e. from 250 percent and over to zero percent.

Over-dry Method

The oven-dry method requires a saw to cut the section, an accurate weight scale and an oven.

The following describes how to implement the oven-dry method to determine moisture content.

Crosscut a 1 inch section from a board and remove any bark, loose fibers, bark and sawdust.

Immediately weigh the sample on a scale with a precision of 0.1% of the weight of the sample (A 500g electronic scale with a precision of 0.1g is ideal for weighing sections):

Record the weight as the Green Weight:

Dry the section in a forced convection oven maintained at a temperature of 215 0^F to 220 0^F so that all the water is removed. This typically takes about 24 hours and can be confirmed by weighing the sections at 1-hour intervals. All the water is removed when weight loss ceases.

After weight losses ceases, immediately reweigh the section and record the weight as the oven dry Weight;

The moisture content of the wood is determined using the following formula:

$$mc(\%) = \frac{(Greenweight - Oven-dryweight)}{Oven-dryweight} \times 100$$

UNIVERSITY OF IBADAN

APPENDIX 5

DETERMINATION OF THE EFFECT OF WATER ON COMMON NAIL

Experiment was carried out to determine the effect of water on common nails, because the strength of nail joint is dependent on the size and density of nails at the joint. The various sizes of common nails available in the market were put in water and observed for a period of ninety days. The loss in weight was noticed and recorded.

Objectives: To determine the effects of water on nails

Materials: Beam balance, Nails of different diameters and types, water bowls.

Method: The common nails in the market were observed and weighed before putting them in water in an open plastic for 90 days.
The nails were observed every ten days; they are oven dried and re-weighed each time. The observed loss in weight is as contained in table 2

APPENDIX 6: PROGRAMMING

NEW PROGRAM

```
C PROGRAM ANGLE OF ATTACK
C BUILDING LENGHT PARRALLEL TO THE MAIN WIND DIRECTION
REAL B,Z,TITA,Q,T,T1,T2,I,NO,TCA
OPEN(UNIT=1,FILE="C:\FORT\ANGLE.TXT")
OPEN(UNIT=2,FILE="C:\FORT\ANGLEOUT.TXT")
OPEN(3,FILE="C:\FORT\NO.TXT")
OPEN(4,FILE="C:\FORT\FORCEOUT.TXT")
READ(3,*)NO
DO I=1,NO
READ(1,*)TITA,B,Z
READ(4,*)F
Q=(3.14/180)
T=90-TITA
T1=Z*(COS(T*Q))
T2=B*COS(TITA*Q)
CA=(T1+T2)/B
IF(TITA .GT. 0) THEN
TCA=CA*F
WRITE(2,5)TCA
5 FORMAT(F8.3)
GO TO 9
ELSE
TCA=CA
WRITE(2,7)TCA
7 FORMAT(F8.3)
9 ENDIF
CONTINUE
ENDDO
END
```

NEW PROGRAM

```
REAL Q,I,NO
C K=RATIO OF BREATH TO LENGHT B=BREATH OF RATIO
C TITA=ROOF MAIN ANGLE X=ALPHA SAMPHER ANGLE
C Y=PROJECTED SAMPHER LENGHT
REAL TITA,B,GAMMA,Z
OPEN(UNIT=1,FILE="C:\FORT\AREA1.TXT")
OPEN(UNIT=3,FILE="C:\FORT\AREAOUT.TXT")
OPEN(UNIT=4,FILE="C:\FORT\VAT2.TXT")
OPEN(5,FILE="C:\FORT\NO.TXT")
READ(5,*)NO
DO I=1,NO
READ(1,*)TITA,GAMMA,B,Z
Q=(3.14/180)
X1=(Z*SIN(GAMMA*Q)+B)* COS(TITA*Q)
X2=(Z*SIN(GAMMA*Q)*COS(TITA*Q))+B
AR=X1/X2
WRITE(3,10)AR
10 FORMAT(F5.2)
WRITE(4,12)TITA,B
12 FORMAT(F6.2,F6.2,F6.2,F6.2)
CONTINUE
ENDDO
END
```

NEW PROGRAM

```
C PROGRAM FOR FORCE RATIO
C TITA IS INPUT
REAL Q2,Q3,Q,Q4,Q5
REAL TITA,Q1,I,NO
OPEN(UNIT=1,FILE="C:\FORT\FORCE.TXT")
```

```

OPEN(UNIT=2,FILE="C:\FORT\FORCEOUT.TXT")
OPEN(3,FILE="C:\FORT\NO.TXT")
READ(3,*)NO
DO I=1,NO
  READ(1,5)TITA
5  FORMAT(F4.1)
  Q=(3.14/180)
  Q1=COS(TITA*Q)
  Q5=90-TITA
  Q2=SIN(Q5*Q)
  Q4=Q2*Q2
  Q3=Q4/Q1
  WRITE(2,10)Q3
10 FORMAT(F8.3)
  CONTINUE
ENDDO
END

```

NEW PROGRAM

```

C  PROGRAM FOR TIME/PROB
  REAL P,A,B,T,Y,V,VM,I,NO,P2

  OPEN(UNIT=1,FILE="C:\FORT\PROB.TXT")
  OPEN(UNIT=2,FILE="C:\FORT\PROBOUT.TXT")
  OPEN(3,FILE="C:\FORT\NO.TXT")
  READ(3,*)NO
  DO I=1,NO
  READ(1,*)P,P2
  WRITE(*,2)P,P2
2  FORMAT(F5.2,F5.2)
  T=1/(1-P)

```

```

Y2=(-ALOG(P))
Y1=(-ALOG(Y2))
Y3=(-ALOG(P2))
Y4=(-ALOG(Y3))
Y =Y4+Y1
A=13.09/1.14132
B=97.11-(0.54362*A)
V=(A*Y) + B
VM=0.278*V
WRITE(2,10)VM
10 FORMAT(F5.2)
C  END IF
CONTINUE
ENDDO
END

```

NEW PROGRAM

```

C  PROGRAM TOPOGRAHICAL
C  L=LENGHT ALONG SLOPE, GAMMA
INTEGER I,NO
REAL GAMMA,VD,VS,Q,L,VIS
REAL H,K1,K2,K3,K4,K5,K6
OPEN(UNIT=1,FILE="C:\FORT\TOPO.TXT")
OPEN(UNIT=2,FILE="C:\FORT\TOPOOUT.TXT")
OPEN(UNIT=3,FILE="C:\FORT\PROBOUT.TXT")
OPEN(5,FILE="C:\FORT\NO.TXT")
READ(5,*)NO
DO I =1,NO
READ(1,*)GAMMA,L,Y
READ(3,*)VD
IF(GAMMA .EQ. 0) THEN

```

```

VS=VD
WRITE (2,5)VS
5 FORMAT(F8.3)
GOTO 9
ELSE
Q=(3.14/180)
H=L*SIN(GAMMA*Q)
K1=((H+(2+Y))*H)/((H+Y)*(H+Y))
K2=((SIN(GAMMA*Q))+COS(GAMMA*Q))**(1.286)
K3=(COS(GAMMA*Q))-(SIN(GAMMA*Q))
K4=K2/K3
K5=((SIN(GAMMA*Q))**(1.286))/COS(GAMMA*Q)
K6=K1*(K4-K5)
VIS=0.9984*(K6)*(VD*VD)
VS=SQRT(VIS)
WRITE (2,10)VS
10 FORMAT(F8.3)
9 END IF
CONTINUE
ENDDO
END

```

C NEW PROGRAM

```

INTEGER I,NO
REAL TITA,Z1,Pai,W,P,PAO
REAL A2,A1,D,BT,L,FY,DC,C,BC,FCU
REAL VAT,Q1
REAL DIA,N,M,LHB,Q,LE1,LE2
REAL B,KG,X1,K
OPEN(UNIT=1,FILE="C:\FORT\VAT.TXT")
OPEN(UNIT=2,FILE="C:\FORT\VAT2.TXT")

```

```

OPEN(UNIT=3,FILE="C:\FORT\VATOUT.TXT")
OPEN(UNIT=4,FILE="C:\FORT\ANGLEOUT.TXT")
OPEN(UNIT=5,FILE="C:\FORT\AREAOUT.TXT")
OPEN(UNIT=6,FILE="C:\FORT\TOPOOUT.TXT")
OPEN(UNIT=7,FILE="C:\FORT\XBAR.TXT")
OPEN(8,FILE="C:\FORT\NO.TXT")
READ(8,*)NO
DO I =1,NO
READ(1,*)Z1,SR,PAI,PAO,DC,C,FY,BC,DIA,FCU,N,M,KG
READ(2,*)TITA,B
READ(7,*)A1,A2,D,BT,L
C  CALCULATE VOLUME OF ATTIC
Q=(3.14/180)
VAT=0.25*Z1*B*TAN(TITA*Q)

C  CALCULATE WEIGHT OF AIR IN THE ATTIC
AW=PAI*0.25*Z1*(B*TAN(TITA*Q))
C  CALCULATE MASS
K=B/Z1
Y1=(B/2 *(TAN(A1*Q)))*(SQRT(1+(TAN(TITA*Q))*(TAN(TITA*Q))))
Y2=(B/2 *(TAN(A2*Q)))*(SQRT(1+(TAN(TITA*Q))*(TAN(TITA*Q))))
QT1=Y1/Z1
QT2=Y2/Z1
Q1=(K*Z1)/0.7
Q2=(Z1-(Q1+Q2)*Z1+1.05)/1.05
Q3=1+(1/COS(TITA*Q))+N/4*TAN(TITA*Q)
Q4=((Q1*Z1)/0.7)
Q5=(K*Z1+1.05)/1.05
Q6=1+(1/COS(A1*Q))+M/4*TAN(A1*Q)

Q7=((Q2*Z1)/0.7)

```

$$Q8=(K*Z1+1.05)/1.05$$

$$Q9=1+(1/\text{COS}(A2*Q))+M/4*\text{TAN}(A2*Q)$$

$$\text{MASSA}=(Q1*(Q2*Q3))+(Q4*(Q5*Q6))+(Q7*(Q8*Q9))$$

$$L2=(K*Z1/0.7)*(1+(1/(\text{COS}(\text{TITA}*Q))))+(N/4)*\text{TAN}(\text{TITA}*Q)$$

$$L5=((Z1+1.05)/1.05)*L2$$

$$\text{MASSB}=L5$$

$$\text{WR}=\text{MASSA}/\text{MASSB}$$

$$P=1.5/\text{SR}$$

$$W1 =0.5*(\text{COS}(\text{TITA}*Q))$$

$$W2=K*((0.73+(1.49*P)+(1.43*P)*(1+\text{TAN}(\text{TITA}*Q))))$$

$$W3=(K*Z1)*((1.9*P)+1.78+0.077*(\text{COS}(\text{TITA}*Q)))$$

$$W4=(K*Z1)*((N*P/4)*(\text{TAN}(\text{TITA}*Q)))$$

$$\text{WG}=(Z1*(W1+W2+W3+W4))*0.04875$$

$$W=\text{WR}*(\text{WG}-(0.266*(K*(Z1*Z1)+((1+K)*Z1))))+\text{WG}$$

C READ VALUES FROM ANGLE AND AREA OUTPUT FILE

READ(4,*)CA

READ(5,*)AR

$$\text{AG}=K*(B*B)/(\text{COS}(\text{TITA}*Q))$$

$$\text{PA}=CA*AR*AG$$

C CALCULATE WIND FORCE READ FROM PROBOUT FILE

READ(6,*)V

$$\text{WF}=\text{PAO} * ((V*V)/2)*\text{PA}*(\text{SQRT}(0.9*0.9))*\text{KG}$$

C OVERTURNING MOMENT

$$\text{MO}=\text{WF}*(B/2*(\text{TAN}(\text{TITA}*Q)))$$

$$\text{LHB}=0$$

C CALCULATE FOR XBAR

$$X1=A1*A1*A1*\text{COS}(\text{TITA}*Q)*\text{COS}(\text{BT}*Q)$$

$$X2=A2*(3-A2)*\text{COS}(\text{TITA}*Q)*\text{COS}(\text{D}*Q)$$

$$X3=3.0*(1-A1-A2)*(1-A1-A2)*(1-A1-A2)$$

$$X4=X1+X2+X3$$

$$X5=A2*\text{COS}(D*Q)*\text{COS}(TITA*Q)$$

$$X6=A1*\text{COS}(BT*Q)*\text{COS}(TITA*Q)$$

$$X7=(1-A2-A2)*\text{COS}(BT*Q)*\text{COS}(D*Q)$$

$$X8=X5+X8+X7$$

$$XBAR=X4/X8*L/6$$

C RESISTING MOMENT

$$MR=(W+AW)*XBAR)*10$$

C CHECK FOR BLOWING OFF

IF(MR .GE. MO) THEN

WRITE(3,15)I

C 15 FORMAT(I2,' THE ROOF WILL NOT BLOW OFF')

ELSE

WRITE(3,20)I

20 FORMAT (I2,' THE ROOF WILL BLOW OFF')

C DESIGN FOR BALANCING MOMENT

$$MB=MO-MR$$

$$DCE=DC-C$$

C AREA REQUIRED

$$ASRA=MB/0.00087*FY*DCE$$

C CALCULATE L EFFECTIVE

$$LE1=40*BC$$

$$LE2=(100*(BC*BC))/DC$$

$$LE3=(250*BC)/12$$

$$LE=\text{MIN}(LE1,LE2,LE3)$$

C DESIGN AS THREE PIERS

$$F=MB/B$$

$$ASP=((F/3)-0.00035*FCU*BC*DC)/0.6*FY$$

$$AS1=\text{MIN}(ASP,ASRA)$$

IF (AS1 .LE. 0) THEN

WRITE(3,22)

```

22 FORMAT('PROVIDE FOR HOLD DOWN BOLT')
    LHB =(0.125*FY*DIA)/(BC*FCU)
    WRITE(3,10)LHB
10 FORMAT(F8.3)
    END IF
    IF (AS1 .GT. 0 .AND. AS1 .LT. (0.25/100*BC*DC)) THEN
    WRITE(3,24)
24 FORMAT('PROVIDE NOMINAL REINFORCEMENT')
    ELSE
    WRITE(3,23)AS1,LE,LHB
23 FORMAT('AS1 =',F15.3,I5,F8.3)
    END IF
    END IF
    CONTINUE
    ENDDO
    END

```

UNIVERSITY OF IBADAN

APPENDIX 7: PROGRAMM INSTRUCTIONS

Program for calculating angle of attack factor

Data File: Angle

Output File: Angle.out

Description of Data File

1st entry e.g 30^0 = Roof main angle

2nd entry e.g 15^0 = Orientation to the wind direction

3rd entry e.g 7m = Breadth of building

4th entry e.g 10m = Length of building

Program for calculating area under wind action

Data File: Area

Output File: Area.out

Description of Data File

1st entry e.g 0.1 = Ratio of first projected bevel length to the length of the building

2nd entry e.g 0.25 = Ratio of second projected bevel length to the length of the building

3rd entry e.g 25^0 = First angle of slope at the first projected length

4th entry e.g 35^0 = second angle of slope at the second projected length

5th entry e.g 10m = Length of building

Program for calculating design wind speed at plain ground

Data File: Prob

Output File: Prob.out

Description of Data File

1st entry e.g 0.95 = Probability of non-occurrence

2nd entry e.g 0.368 = Margin of risk level

Program for calculating design wind speed uphill

Data File: Topo

Output File: Topo.out

Description of Data File

1st entry e.g 10^0 = Slope of the hill

2nd entry e.g 100m = Length of the hill measured along the slope

3rd entry e.g 6m = Height of the referenced point above the ground

Program for calculating the centre of gravity of the roof

Data File: Xbar

Out put File: Xbar.out

Description of Data File

1st entry e.g 0.1 = Ratio of first projected bevel length to the length of the building

2nd entry e.g 0.25 = Ratio of second projected bevel length to the length of the building

3rd entry e.g 25° = First angle of slope at the first projected length

4th entry e.g 35° = second angle of slope at the second projected length

5th entry e.g 10m = Length of building

Program for calculating overturning moment, resisting moment, predictions and

precautionary measures

Data File: Vat

Out put File: Vat.out

Description of Data File

1st entry e.g 10m = Length of the building

2nd entry e.g 1.25 = Spacing of the rafter

3rd entry e.g 1.132 = Air density inside the roof

4th entry e.g 1.187 = Ambient air density

5th entry e.g 350mm = Depth of concrete casing

6th entry e.g 30mm = Cover to the reinforcement

7th entry e.g 410N/mm^2 = Characteristic strength of the reinforcement

8th entry e.g 200mm = Breadth of the concrete casing

9th entry e.g 20mm = Diameter of reinforcement

10th entry e.g 30N/mm^2 = Characteristic strength of concrete

11th entry e.g 8 = Number of main panel

12th entry e.g 6 = Number of secondary panel

13th entry e.g = Environmental factor

APPENDIX 8: DATA ENTRY
SET ONE

0.00,10.00,15.00
0.00,12.00,17.10
0.00,10.00,20.00
0.00,7.50,11.50
0.00,12.00,20.00
0.00,12.00,30.40
0.00,3.50,9.50
0.00,13.50,32.00
0.00,12.00,14.00
0.00,5.00,12.00
0.00,7.50,11.50
0.00,12.00,20.00
12.50,0.00,10.00,15.00
22.50,0.00,12.00,17.10
20.00,0.00,10.00,20.00
15.00,0.00,7.50,11.50
20.00,0.00,12.00,20.00
22.20,0.00,12.00,30.40
15.50,0.00,3.50,9.50
25.00,0.00,13.50,32.00
15.00,0.00,12.00,14.00
15.00,0.00,5.00,12.00
15.00,0.00,7.50,11.50
30.00,0.00,12.00,20.00
12.50
22.50
30.00
15.00

30.00
22.50
15.00
25.00
15.00
20.00
15.00
30.00
0.95,0.36
0.95,0.36
0.95,0.36
0.95,0.36
0.95,0.36
0.95,0.36
0.95,0.36
0.95,0.36
0.95,0.36
0.95,0.36
0.95,0.36
0.95,0.36
0.00,10.00,3.00
0.00,10.00,3.00
0.00,10.00,3.00
0.00,10.00,3.00
0.00,10.00,3.00
0.00,10.00,3.00
0.00,10.00,3.00
0.00,10.00,3.00
0.00,10.00,3.00
0.00,100.00,3.00
0.00,20.00,3.00
0.00,0.00,3.00

0.00,0.00,3.00
30.00,1.80,1.14,1.18,400.00,40.00,250.00,200.00,20.00,25.00,12.00,0.00,1.59
15.00,1.50,1.14,1.18,400.00,40.00,250.00,200.00,20.00,30.00,8.00,0.00,1.59
11.70,1.50,1.14,1.18,375.00,30.00,250.00,200.00,20.00,30.00,10.00,0.00,1.59
42.00,1.50,1.14,1.18,350.00,50.00,410.00,175.00,20.00,20.00,6.00,0.00,1.59
12.30,1.20,1.14,1.18,400.00,30.00,250.00,200.00,20.00,30.00,6.00,0.00,1.59
15.00,1.50,1.14,1.18,500.00,30.00,250.00,225.00,12.00,30.00,8.00,0.00,2.20
17.10,1.20,1.14,1.18,500.00,25.00,250.00,200.00,12.00,30.00,8.00,0.00,2.20
20.00,1.50,1.15,1.19,450.00,25.00,250.00,200.00,20.00,30.00,8.00,0.00,2.20
12.00,1.00,1.14,1.18,400.00,25.00,450.00,200.00,20.00,30.00,8.00,0.00,1.59
20.00,1.00,1.14,1.18,400.00,20.00,250.00,200.00,20.00,30.00,8.00,0.00,1.59
30.40,1.00,1.14,1.18,400.00,30.00,250.00,200.00,20.00,30.00,8.00,0.00,1.59
0.00,0.00,0.00,0.00,15.00
0.00,0.00,0.00,0.00,17.10
0.00,0.00,0.00,0.00,12.00
0.00,0.00,0.00,0.00,12.00
0.00,0.00,0.00,0.00,20.00
0.00,0.00,0.00,0.00,14.00
0.00,0.00,0.00,0.00,32.00
0.00,0.00,0.00,0.00,9.50
0.00,0.00,0.00,0.00,11.50
0.00,0.00,0.00,0.00,24.00
0.00,0.00,0.00,0.00,16.00
0.00,0.00,0.00,0.00,11.50

SET TWO

0.00,12.00,17.10

10.00,10.00,20.00

0.00,7.50,11.50

10.00,12.00,20.00

10.00,12.00,30.40

10.00,3.50,9.50

10.00,13.50,32.00

10.00,12.00,14.00

0.00,5.00,12.00

10.00,7.50,11.50

10.00,12.00,20.00

0.00,12.00,30.40

22.50,0.00,12.00,17.10

20.00,0.00,10.00,20.00

15.00,0.00,7.50,11.50

20.00,0.00,12.00,20.00

22.20,0.00,12.00,30.40

15.50,0.00,3.50,9.50

25.00,0.00,13.50,32.00

15.00,0.00,12.00,14.00

15.00,0.00,5.00,12.00

15.00,0.00,7.50,11.50

30.00,0.00,12.00,20.00

22.50,0.00,12.00,30.40

12.50

22.50

30.00

15.00

30.00

22.50

15.00

25.00

15.00

20.00

15.00

0.99,0.36

0.95,0.36

0.99,0.36

0.95,0.36

0.99,0.36

0.99,0.36

0.99,0.36

0.99,0.36

0.99,0.36

0.95,0.36

0.99,0.36

0.99,0.36

30.00,150.00,3.00

15.00,100.00,3.00

20.00,150.00,3.00

15.00,100.00,3.00

30.00,120.00,3.00

40.00,150.00,3.00

35.00,120.00,3.00

30.00,105.00,3.00

35.00,100.00,3.00

35.00,125.00,3.00

30.00,120.00,3.00

39.00,100.00,3.00

30.00,1.80,1.14,1.18,400.00,40.00,250.00,200.00,20.00,25.00,12.00,0.00,1.59

15.00,1.50,1.14,1.18,400.00,40.00,250.00,200.00,20.00,30.00,8.00,0.00,1.59

11.70,1.50,1.14,1.18,375.00,30.00,250.00,200.00,20.00,30.00,10.00,0.00,1.59
42.00,1.50,1.14,1.18,350.00,50.00,410.00,175.00,20.00,20.00,6.00,0.00,1.59
12.30,1.20,1.14,1.18,400.00,30.00,250.00,200.00,20.00,30.00,6.00,0.00,1.59
15.00,1.50,1.14,1.18,500.00,30.00,250.00,225.00,12.00,30.00,8.00,0.00,2.20
17.10,1.20,1.14,1.18,500.00,25.00,250.00,200.00,12.00,30.00,8.00,0.00,2.20
20.00,1.50,1.15,1.19,450.00,25.00,250.00,200.00,20.00,30.00,8.00,0.00,2.20
12.00,1.00,1.14,1.18,400.00,25.00,450.00,200.00,20.00,30.00,8.00,0.00,1.59
20.00,1.00,1.14,1.18,400.00,20.00,250.00,200.00,20.00,30.00,8.00,0.00,1.59
30.40,1.00,1.14,1.18,400.00,30.00,250.00,200.00,20.00,30.00,8.00,0.00,1.59
9.50,1.00,1.14,1.18,400.00,300.00,250.00,200.00,20.00,30.00,8.00,0.00,1.59
0.00,0.00,0.00,0.00,15.00
0.00,0.00,0.00,0.00,17.10
0.00,0.00,0.00,0.00,12.00
0.00,0.00,0.00,0.00,12.00
0.00,0.00,0.00,0.00,20.00
0.00,0.00,0.00,0.00,14.00
0.00,0.00,0.00,0.00,32.00
0.00,0.00,0.00,0.00,9.50
0.00,0.00,0.00,0.00,11.50
0.00,0.00,0.00,0.00,24.00
0.00,0.00,0.00,0.00,16.00
0.00,0.00,0.00,0.00,11.50

SET THREE

10.00,7.50,11.50

10.00,12.00,20.00

0.00,12.00,30.40

0.00,10.00,24.00

0.00,14.00,25.00

0.00,9.40,11.50

0.00,9.20,19.50

0.00,12.00,30.40

0.00,4.20,12.00

0.00,9.30,10.60

0.00,3.00,12.00

0.00,6.00,15.00

15.00,0.00,7.50,11.50

30.00,0.00,12.00,20.00

22.50,0.00,12.00,30.40

20.00,0.00,10.00,24.00

27.50,0.00,14.00,25.00

20.00,0.00,9.40,11.50

15.00,0.00,9.20,19.50

17.50,0.00,12.00,30.40

10.00,0.00,4.20,12.00

40.00,0.00,9.30,10.60

25.00,0.00,3.00,12.00

20.00,0.00,6.00,15.00

15.00

30.00

22.50

15.00

25.00

15.00
20.00
15.00
30.00
22.50
20.00
27.50
0.99,0.36
0.95,0.36
0.99,0.36
0.95,0.36
0.99,0.36
0.99,0.36
0.99,0.36
0.99,0.36
0.99,0.36
0.95,0.36
0.99,0.36
0.99,0.36
30.00,150.00,3.00
15.00,100.00,3.00
20.00,150.00,3.00
15.00,100.00,3.00
30.00,120.00,3.00
40.00,150.00,3.00
35.00,120.00,3.00
30.00,105.00,3.00
35.00,100.00,3.00
35.00,125.00,3.00
30.00,120.00,3.00
39.00,100.00,3.00

12.00,1.00,1.14,1.18,400.00,25.00,450.00,200.00,20.00,30.00,8.00,0.00,1.59
20.00,1.00,1.14,1.18,400.00,20.00,250.00,200.00,20.00,30.00,8.00,0.00,1.59
30.40,1.00,1.14,1.18,400.00,30.00,250.00,200.00,20.00,30.00,8.00,0.00,1.59
9.50,1.00,1.14,1.18,400.00,300.00,250.00,200.00,20.00,30.00,8.00,0.00,1.59
32.00,1.20,1.14,1.18,400.00,30.00,250.00,200.00,20.00,30.00,8.00,0.00,1.59
14.00,1.20,1.14,1.18,400.00,30.00,250.00,200.00,20.00,30.00,8.00,0.00,1.59
12.00,1.50,1.14,1.18,400.00,30.00,250.00,200.00,20.00,30.00,8.00,0.00,1.59
11.50,1.50,1.14,1.18,400.00,20.00,250.00,150.00,20.00,30.00,8.00,0.00,1.59
11.50,1.50,1.14,1.18,500.00,20.00,410.00,200.00,16.00,30.00,8.00,0.00,1.59
20.00,1.50,1.14,1.18,450.00,30.00,250.00,200.00,20.00,20.00,8.00,0.00,1.59
30.40,1.50,1.14,1.18,400.00,40.00,250.00,200.00,16.00,30.00,8.00,0.00,1.59
24.10,1.50,1.14,1.18,500.00,50.00,250.00,225.00,20.00,25.00,8.00,0.00,1.59
0.00,0.00,0.00,0.00,12.00
0.00,0.00,0.00,0.00,12.00
0.00,0.00,0.00,0.00,20.00
0.00,0.00,0.00,0.00,14.00
0.00,0.00,0.00,0.00,32.00
0.00,0.00,0.00,0.00,9.50
0.00,0.00,0.00,0.00,11.50
0.00,0.00,0.00,0.00,24.00
0.00,0.00,0.00,0.00,16.00
0.00,0.00,0.00,0.00,11.50
0.00,0.00,0.00,0.00,20.00
0.00,0.00,0.00,0.00,30.40

SET FOUR

20.00,10.00,27.10

22.50,12.20,27.60

20.00,12.30,9.30

22.50,5.40,13.20

20.00,12.10,14.80

12.50,10.00,15.00

22.50,12.00,22.50

12.50,10.00,15.00

22.50,12.00,17.10

15.00,7.50,11.50

17.50,12.00,30.40

10.00,4.20,12.00

20.00,60.00,10.00,27.10

22.50,30.00,12.20,27.60

20.00,30.00,9.30,12.30

22.50,15.00,5.40,13.20

20.00,15.00,12.10,14.80

12.50,45.00,10.00,15.00

22.50,30.00,12.00,17.00

12.50,30.00,10.00,15.00

22.50,30.00,12.00,17.10

15.00,25.00,7.50,11.50

17.50,20.00,12.00,30.40

20.00

22.50

20.00

22.50

20.00

12.50

22.50

12.50

22.50

15.00

17.50

10.00

0.99,0.70

0.99,0.70

0.99,0.70

0.99,0.70

0.99,0.70

0.99,0.80

0.99,0.70

0.99,0.70

0.99,0.70

0.99,0.70

0.99,0.70

0.99,0.70

0.00,0.00,0.00

0.00,0.00,0.00

44.00,150.00,0.00

0.00,0.00,0.00

25.00,200.00,0.00

15.00,250.00,0.00

40.00,100.00,0.00

5.00,400.00,0.00

0.00,0.00,0.00

0.00,0.00,0.00

0.00,0.00,0.00

0.00,0.00,0.00

27.10,1.20,1.13,1.18,500.00,40.00,410.00,150.00,12.00,25.00,10.00,0.00,2.20

27.60,1.20,1.13,1.18,400.00,25.00,410.00,150.00,12.00,25.00,10.00,6.00,2.20

12.30,1.20,1.13,1.18,500.00,25.00,250.00,125.00,12.00,25.00,6.00,0.00,2.20
13.20,1.50,1.13,1.18,475.00,25.00,410.00,150.00,12.00,250.00,4.00,4.00,2.20
14.80,1.20,1.13,1.18,475.00,25.00,250.00,200.00,12.00,25.00,8.00,0.00,2.20
15.00,1.50,1.13,1.18,400.00,30.00,250.00,200.00,12.00,25.00,10.00,8.00,2.20
17.10,1.20,1.13,1.18,475.00,30.00,250.00,175.00,12.00,25.00,10.00,0.00,2.20
15.00,1.50,1.13,1.18,475.00,40.00,250.00,200.00,12.00,25.00,10.00,8.00,2.20
17.10,1.20,1.13,1.18,475.00,30.00,250.00,200.00,12.00,25.00,10.00,0.00,2.20
11.50,1.50,1.13,1.18,475.00,30.00,250.00,180.00,12.00,25.00,6.00,4.00,2.20
30.40,1.20,1.13,1.18,475.00,30.00,250.00,200.00,30.00,25.00,10.00,0.00,2.20
12.00,1.80,1.13,1.18,400.00,50.00,250.00,200.00,12.00,25.00,4.00,4.00,2.20
0.00,0.00,0.00,0.00,27.10
0.14,0.14,30.00,30.00,27.60
0.00,0.00,0.00,0.00,12.30
0.13,0.13,30.00,30.00,13.20
0.00,0.00,0.00,0.00,14.80
0.20,0.20,30.00,30.00,15.00
0.00,0.00,0.00,0.00,17.10
0.20,0.20,30.00,30.00,15.00
0.00,0.00,0.00,0.00,17.10
0.20,0.20,30.00,30.00,11.50
0.00,0.00,0.00,0.00,30.40
0.10,0.10,30.00,30.00,12.00

SET FIVE

40.00,9.20,10.60

25.00,3.00,12.00

20.00,6.00,15.00

20.00,12.00,15.00

25.00,12.00,15.00

30.00,12.00,14.00

12.50,12.00,15.00

17.50,15.00,30.00

15.00,12.00,15.00

15.00,9.10,11.70

30.00,8.40,42.00

20.00,9.30,12.30

40.00,20.00,9.20,10.60

25.00,80.00,3.00,12.00

20.00,60.00,6.00,15.00

20.00,60.00,12.00,15.00

25.00,45.00,12.00,15.00

30.00,30.00,12.00,14.00

12.50,30.00,12.00,15.00

17.50,35.00,15.00,30.00

15.00,80.00,12.00,15.00

15.00,48.00,9.10,11.70

30.00,60.00,8.40,42.00

40.00

25.00

20.00

20.00

25.00

30.00

12.50

17.50

15.00

15.00

30.00

20.00

0.99,0.70

0.99,0.70

0.99,0.70

0.99,0.70

0.99,0.70

0.99,0.80

0.99,0.70

0.99,0.70

0.99,0.70

0.99,0.70

0.99,0.70

0.99,0.70

0.00,0.00,0.00

0.00,0.00,0.00

44.00,150.00,0.00

0.00,0.00,0.00

25.00,200.00,0.00

15.00,250.00,0.00

40.00,100.00,0.00

5.00,400.00,0.00

0.00,0.00,0.00

0.00,0.00,0.00

0.00,0.00,0.00

0.00,0.00,0.00

10.60,1.20,1.13,1.18,450.00,30.00,250.00,200.00,12.00,20.00,8.00,0.00,2.20

12.00,1.20,1.13,1.18,450.00,30.00,250.00,200.00,12.00,25.00,3.00,2.00,2.20

15.00,1.50,1.13,1.18,450.00,25.00,250.00,200.00,12.00,25.00,4.00,0.00,2.20
15.00,1.80,1.13,1.18,450.00,30.00,250.00,200.00,12.00,25.00,10.00,8.00,2.20
15.00,1.50,1.13,1.18,450.00,30.00,250.00,200.00,12.00,25.00,8.00,0.00,2.20
30.00,1.20,1.13,1.18,425.00,30.00,250.00,200.00,12.00,25.00,10.00,8.00,2.20
12.50,1.50,1.13,1.18,400.00,40.00,250.00,200.00,16.00,250.00,12.00,0.00,2.20
30.00,1.80,1.13,1.18,475.00,40.00,250.00,200.00,16.00,25.00,12.00,6.00,2.20
15.00,1.50,1.13,1.18,400.00,30.00,250.00,200.00,16.00,25.00,10.00,0.00,2.20
11.70,1.50,1.13,1.18,425.00,30.00,250.00,180.00,20.00,25.00,8.00,6.00,2.20
42.00,1.50,1.13,1.18,400.00,30.00,250.00,200.00,16.00,25.00,8.00,0.00,2.20
12.30,1.20,1.13,1.18,400.00,30.00,250.00,200.00,12.00,25.00,8.00,6.00,2.20
0.00,0.00,0.00,0.00,10.60
0.12,0.12,30.00,30.00,12.00
0.00,0.00,0.00,0.00,15.00
0.25,0.25,30.00,30.00,15.00
0.00,0.00,0.00,0.00,15.00
0.29,0.29,30.00,30.00,14.00
0.00,0.00,0.00,0.00,15.00
0.15,0.15,30.00,30.00,30.00
0.00,0.00,0.00,0.00,15.00
0.23,0.23,30.00,30.00,11.70
0.00,0.00,0.00,0.00,42.00
0.23,0.23,30.00,30.00,12.30

APPENDIX 9: RESULTS

SET ONE

1 THE ROOF WILL NOT BLOW OFF

2 THE ROOF WILL BLOW OFF

PROVIDE FOR HOLD DOWN BOLT

LHDB = 104.167

ASC = 435.490 LEC = 4166 ASP = -135.534

3 THE ROOF WILL NOT BLOW OFF

4 THE ROOF WILL BLOW OFF

PROVIDE FOR HOLD DOWN BOLT

LHDB = 292.857

ASC = -18052.470 LEC = 3645 ASP = 20074.530

5 THE ROOF WILL NOT BLOW OFF

6 THE ROOF WILL NOT BLOW OFF

7 THE ROOF WILL NOT BLOW OFF

8 THE ROOF WILL NOT BLOW OFF

9 THE ROOF WILL NOT BLOW OFF

10 THE ROOF WILL BLOW OFF

PROVIDE FOR HOLD DOWN BOLT

LHDB = 104.167

ASC = -18997.480 LEC = 4166 ASP = 43185.360

11 THE ROOF WILL NOT BLOW OFF

12 THE ROOF WILL NOT BLOW OFF

SET TWO

1 THE ROOF WILL BLOW OFF

PROVIDE FOR HOLD DOWN BOLT

LHDB = 125.000

ASC = 30.430 LEC = 4166 ASP = -143.076

2 THE ROOF WILL BLOW OFF

PROVIDE FOR HOLD DOWN BOLT

LHDB = 104.167

ASC = 522.814 LEC = 4166 ASP = -118.144

3 THE ROOF WILL NOT BLOW OFF

4 THE ROOF WILL BLOW OFF

ASC = 7642.612 LEC = 3645 ASP = 1405.884

5 THE ROOF WILL BLOW OFF

ASC = 3998.261 LEC = 4166 ASP = 10139.460

6 THE ROOF WILL BLOW OFF

ASC = 8435.267 LEC = 4687 ASP = 20243.840

7 THE ROOF WILL NOT BLOW OFF

8 THE ROOF WILL NOT BLOW OFF

9 THE ROOF WILL BLOW OFF

ASC = 4522.935 LEC = 4166 ASP = 45954.790

10 THE ROOF WILL BLOW OFF

PROVIDE FOR HOLD DOWN BOLT

LHDB = 104.167

ASC = -13345.470 LEC = 4166 ASP = 13689.690

11 THE ROOF WILL NOT BLOW OFF

12 THE ROOF WILL BLOW OFF

SET THREE

1 THE ROOF WILL BLOW OFF

PROVIDE FOR HOLD DOWN BOLT

LHDB = 187.500

ASC = 13.076 LEC = 4166 ASP = -308.601

2 THE ROOF WILL BLOW OFF

PROVIDE FOR HOLD DOWN BOLT

LHDB = 104.167

ASC = 16.787 LEC = 4166 ASP = -173.394

3 THE ROOF WILL BLOW OFF

PROVIDE FOR HOLD DOWN BOLT

LHDB = 104.167

ASC = 633.877 LEC = 4166 ASP = -115.959

4 THE ROOF WILL BLOW OFF

PROVIDE FOR HOLD DOWN BOLT

LHDB = 104.167

ASC = 5232.572 LEC = 4166 ASP = -16.933

5 THE ROOF WILL BLOW OFF

PROVIDE FOR HOLD DOWN BOLT

LHDB = 104.167

ASC = -25153.970 LEC = 4166 ASP = 6338.561

6 THE ROOF WILL BLOW OFF

PROVIDE FOR HOLD DOWN BOLT

LHDB = 104.167

ASC = -8487.597 LEC = 4166 ASP = 11507.770

7 THE ROOF WILL BLOW OFF

PROVIDE FOR HOLD DOWN BOLT

LHDB = 104.167

ASC = -17338.210 LEC = 4166 ASP = 23654.380

8 THE ROOF WILL NOT BLOW OFF

9 THE ROOF WILL NOT BLOW OFF

10 THE ROOF WILL BLOW OFF

ASC = 2206.627 LEC = 4166 ASP = 6598.600

11 THE ROOF WILL NOT BLOW OFF

12 THE ROOF WILL BLOW OFF

PROVIDE FOR HOLD DOWN BOLT

LHDB = 111.111

ASC = -1957.548 LEC = 4687 ASP = 19256.030

UNIVERSITY OF IBADAN

SET FOUR

1 THE ROOF WILL BLOW OFF

PROVIDE FOR HOLD DOWN BOLT

LHDB = 164.000

ASC = 3.336 LEC = 3125 ASP = -133.284

2 THE ROOF WILL BLOW OFF

PROVIDE FOR HOLD DOWN BOLT

LHDB = 164.000

ASC = 220.982 LEC = 3125 ASP = -79.343

3 THE ROOF WILL NOT BLOW OFF

4 THE ROOF WILL BLOW OFF

PROVIDE FOR HOLD DOWN BOLT

LHDB = 16.400

ASC = -6558.061 LEC = 3125 ASP = 12331.060

5 THE ROOF WILL NOT BLOW OFF

6 THE ROOF WILL NOT BLOW OFF

7 THE ROOF WILL NOT BLOW OFF

8 THE ROOF WILL NOT BLOW OFF

9 THE ROOF WILL BLOW OFF

PROVIDE FOR HOLD DOWN BOLT

LHDB = 75.000

ASC = -20356.970 LEC = 4166 ASP = 2544.753

10 THE ROOF WILL BLOW OFF

PROVIDE FOR HOLD DOWN BOLT

LHDB = 83.333

ASC = -15015.190 LEC = 3750 ASP = 5144.253

11 THE ROOF WILL NOT BLOW OFF

12 THE ROOF WILL NOT BLOW OFF

SET FIVE

1 THE ROOF WILL BLOW OFF

PROVIDE FOR HOLD DOWN BOLT

LHDB = 93.750

ASC = 83.737 LEC = 4166 ASP = -105.119

2 THE ROOF WILL BLOW OFF

PROVIDE FOR HOLD DOWN BOLT

LHDB = 75.000

ASC = 24.327 LEC = 4166 ASP = -135.545

3 THE ROOF WILL NOT BLOW OFF

4 THE ROOF WILL BLOW OFF

ASC = 8446.271 LEC = 4166 ASP = 747.184

5 THE ROOF WILL BLOW OFF

PROVIDE FOR HOLD DOWN BOLT

LHDB = 75.000

ASC = -17208.800 LEC = 4166 ASP = 17918.800

6 THE ROOF WILL BLOW OFF

PROVIDE NOMINAL REINFORCEMENT

ASC = 2139.275 66.887

7 THE ROOF WILL BLOW OFF

ASC = 15450.670 LEC = 4166 ASP = 9883.938

8 THE ROOF WILL BLOW OFF

PROVIDE FOR HOLD DOWN BOLT

LHDB = 100.000

ASC = -16465.950 LEC = 4166 ASP = 10342.150

9 THE ROOF WILL NOT BLOW OFF

10 THE ROOF WILL BLOW OFF

PROVIDE FOR HOLD DOWN BOLT

LHDB = 138.889

ASC = -9593.661 LEC = 3750 ASP = 11734.320

11 THE ROOF WILL NOT BLOW OFF

APPENDIX 10: SURVEY STATISTICAL REPRESENTATION

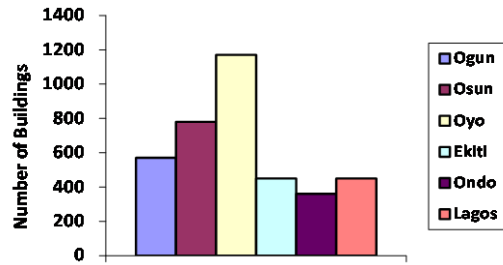

Distribution of Building per State

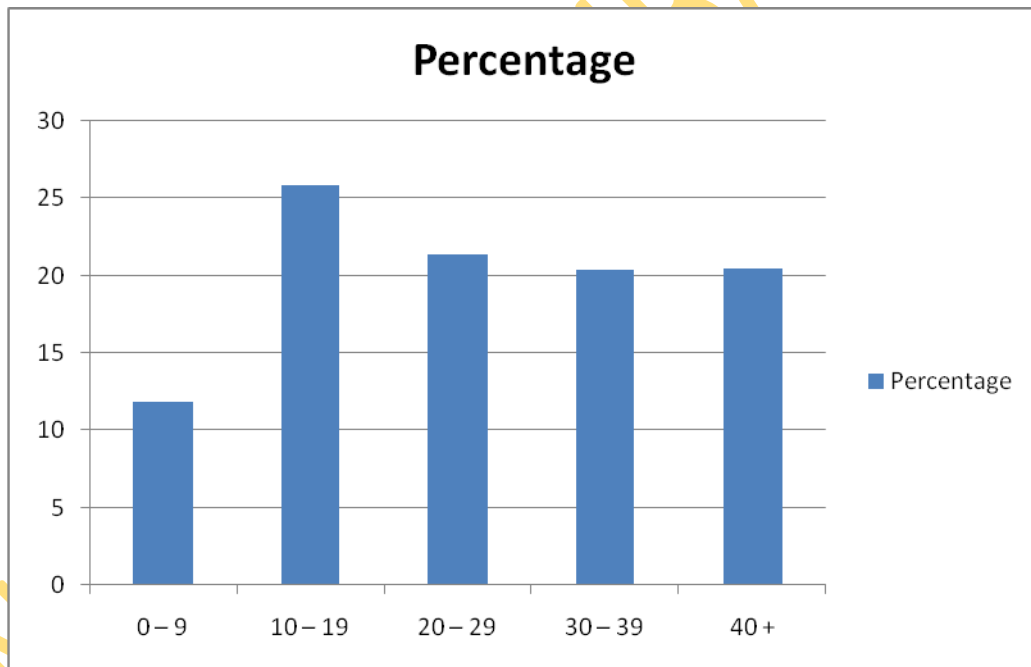

Age Distribution of Roofs

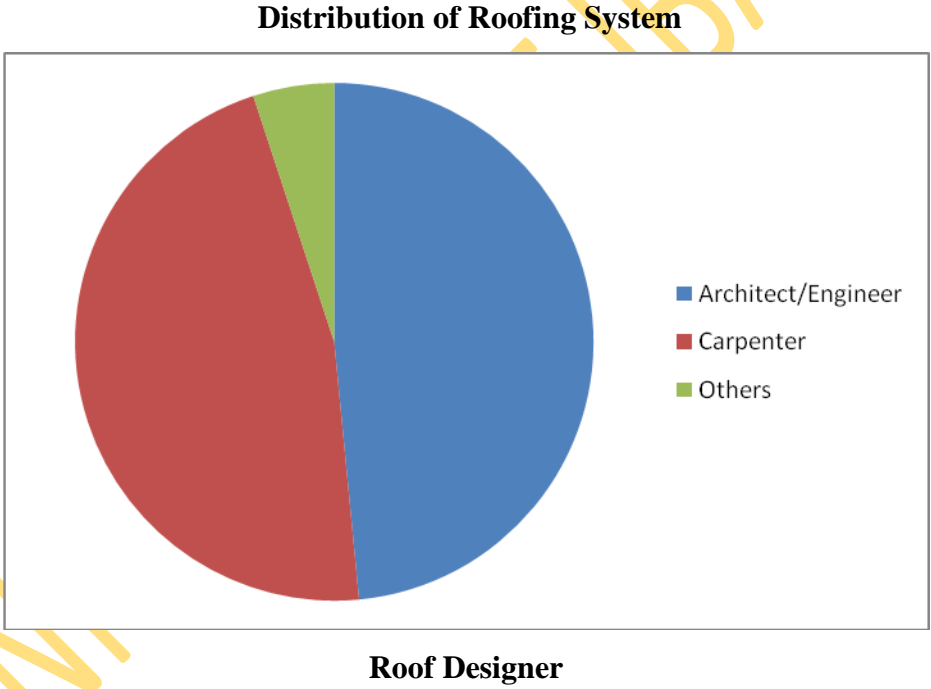
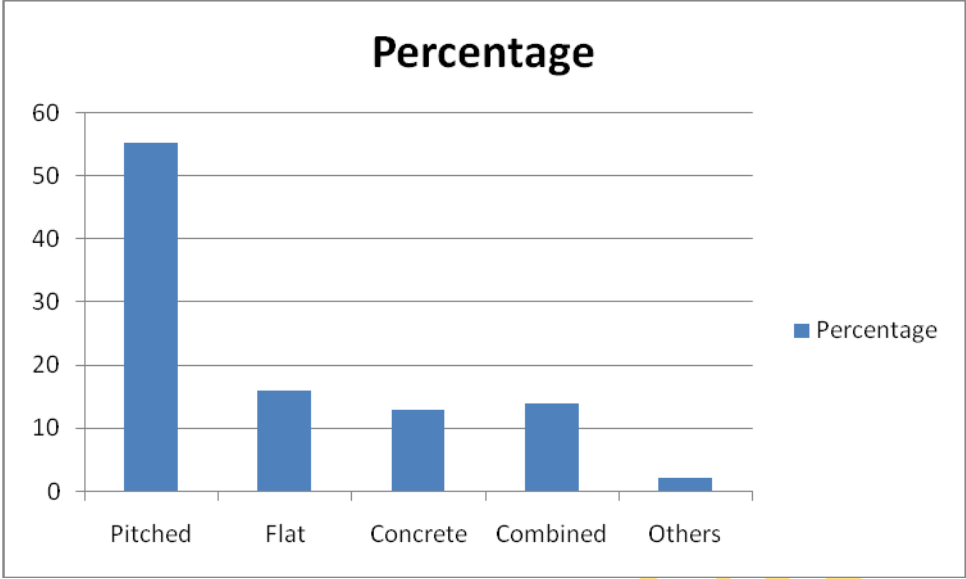

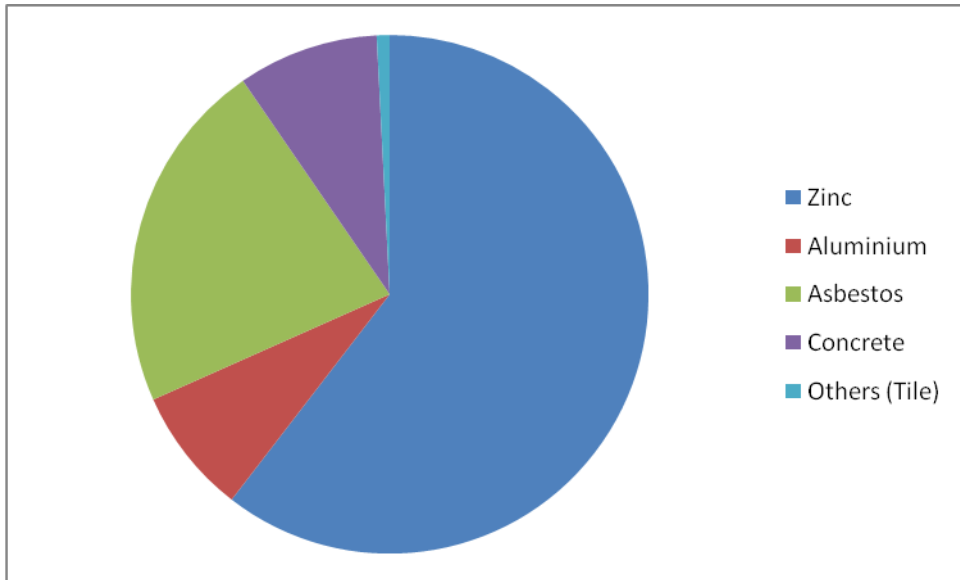

Roof Sheathing Materials

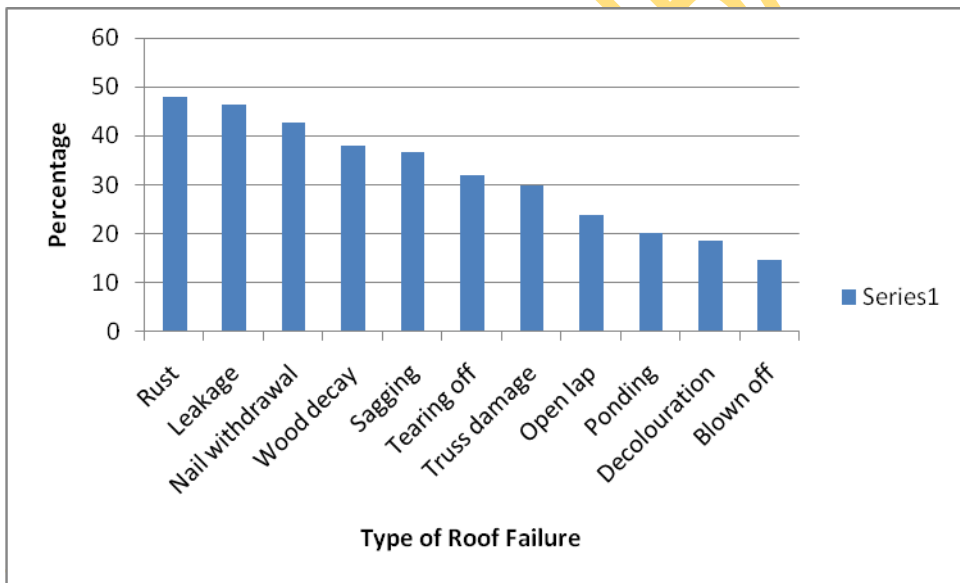

Roof Failure Pattern

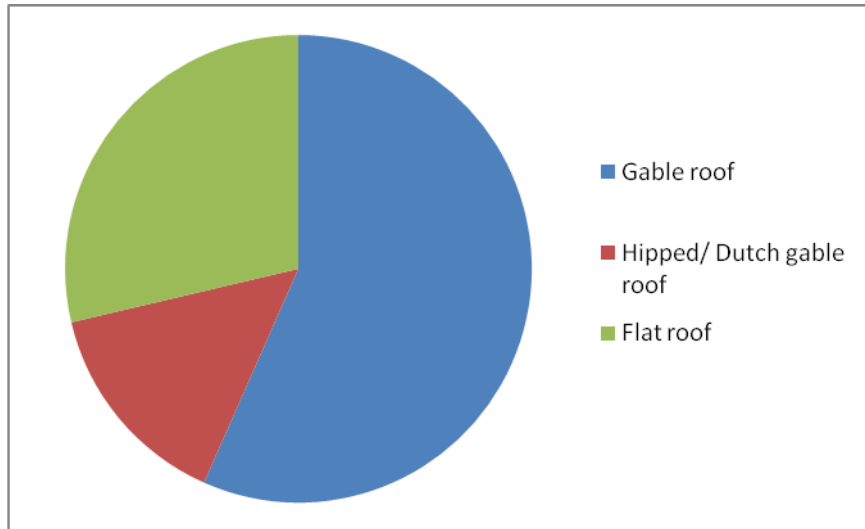

Blown-off based on roof Geometry

UNIVERSITY OF IBADAN