

THE NIGERIAN MICROMETEOROLOGICAL EXPERIMENT (NIMEX-1): AN OVERVIEW

O.O. JEGEDE^{1,†}, M. MAUDER², E.C. OKOGBUE³, T. FOKEN², E.E. BALOGUN^{1,4},
J.A. ADEDOKUN¹, E.O. OLADIRAN⁵, J.A. OMOTOSHO³, A.A. BALOGUN³,
O.R. OLADOSU⁶, L.A. SUNMONU¹, M.A. AYOOLA⁵, T.O. AREGBESOLA⁷, E.O. OGOLO⁶,
E.F. NYMPHAS⁵, M.O. ADENIYI⁵, G.I. OLATONA⁸, K.O. LADIPO³, S.I. OHAMOBI⁴,
E.O. GBOBANIYI⁴ and G.O. AKINLADE¹

1. Department of Physics, Obafemi Awolowo University, Ile-Ife, Nigeria.
2. Department of Micrometeorology, University of Bayreuth, D-95440 Bayreuth, Germany.
3. Department of Meteorology, Federal University of Technology, PMB 704 Akure, Nigeria.
4. African Regional Centre for Space Science and Technology Education-English, Nigeria.
5. Department of Physics, University of Ibadan, Ibadan, Nigeria.
6. Department of Physics, Federal University of Technology, PMB 704 Akure, Nigeria.
7. Institute of Education, Obafemi Awolowo University, Ile-Ife, Nigeria.
8. Department of Physics, Osun State College of Education, Ilesa, Osun State, Nigeria.

(Submitted: 15 July 2004; Accepted: 05 December 2004)

Abstract

The first phase of the Nigerian Micrometeorological Experiment (NIMEX-1) was concluded between 15 February and 10 March 2004, at an agricultural site within the campus of Obafemi Awolowo University in Ile-Ife, Nigeria (7°33'N, 4°33'E). The multi-institutional project was aimed at determining the surface energy balance of a tropical wet and dry location in West Africa. The field observations made fell within a transition from the dry to wet season in the area, and as such, the surface conditions varied in extremes. An integrated measurement system comprising of various micrometeorological sensors was deployed to record the mean and turbulence parameters in the surface layers separately. A number of methodologies viz: the eddy covariance (EC), Bowen ratio energy balance (BREB), and modified Bowen ratio (MBR) systems, used to determine magnitudes of the surface fluxes; sensible and latent heats, were compared. Generally, there is a consistency of their diurnal trends but the BREB method overestimated the surface fluxes up to about 30%. The radiation balance indicated that the incoming shortwave is dominant during daytime and is mainly responsible for the surface forcings. The non-closure of the energy balance obtained at the surface, typically, was less than 25%.

1. Introduction

The active phase of the first Nigerian Micrometeorological Experiment, dubbed the acronym, NIMEX-1, was executed between February 15 and March 10, 2004 at an experimental site within the campus of the Obafemi Awolowo University at Ile-Ife (7°33'N, 4°33'E) in Nigeria. The main aim of the project was to determine the surface energy balance for the conditions of a tropical (wet and dry) area. This research project was a partnership between the following institutions: (1) the Department of Physics at the Obafemi Awolowo University in Ile-Ife, (2) the Department of Physics at the University of Ibadan in Ibadan, (3) the Department of Meteorology at the Federal University of Technology in Akure, (4) the African Regional Centre for Space Science and Technology Education in English also at the Obafemi Awolowo University in Ile-Ife (all

constituting Atmospheric Research Group, ARG, in Nigeria), and (5) the Department of Micrometeorology of the University of Bayreuth at Bayreuth in Germany and the International Programs in the Physical Sciences (IPPS) of Uppsala University, Sweden. Therefore, the *raison-d'être* of organising the multi-institutional NIMEX-1 field project was to strengthen the scientific collaboration between the research groups in Nigeria, and the Department of Micrometeorology, University of Bayreuth and IPPS. By pooling of available resources (manpower, equipment and infrastructures), NIMEX-1 provided intensive micrometeorological field observations that took place within the limited duration of one month, February/March, 2004. The major achievements of the NIMEX-1 field study can be found in Jegede *et al.* (2004).

Briefly, the following research objectives were addressed within the NIMEX-1 field project:

- i. The surface energy balance at a typical agricultural field site in Ile-Ife based on direct measurements of the convective heat, soil heat flux and atmospheric radiation, possibly covering the transition from the dry to the wet season,
- ii. Validation of simple empirical methods for calculating sensible and latent heat fluxes, solar and atmospheric radiation including effects of clouds,
- iii. Evaluation of the existing methods to determine the ground heat flux.

An understanding of the surface energy budget over the land surface is vital for agricultural planning and water resources management. This is the prime motivation for the current research on the surface energy balance of a typical agricultural farm-land in a tropical area, particularly in the context of the changing surface conditions. Also the data acquired can be useful for validating models of the land-surface atmosphere interactions and particularly for the regional and large-scale climate models.

The NIMEX-1 field measurements reported in this paper have been carried out at the Teaching and Research farm of the Obafemi Awolowo University, Ile-Ife, Nigeria (7°33'N, 4°33'E). This data is intended to serve as a base-line for future micrometeorological investigations to be conducted in Ibadan and Akure by the research group, to obtain integrated study of the mesoscale systems in the southwest of Nigeria.

2. Climatology of the study area

The NIMEX-1 study area was in Ile-Ife, Nigeria and as such, it experiences a tropical wet and dry climate (Hastenrath, 1991). The year is roughly divided into two: the wet or rainy season (April to October) and the dry season (November to March). This change of season occurs in association with the meridional movement of the Inter-tropical Discontinuity (ITD) line across west Africa (see Adejokun, 1966; Adedokun, 1978; Balogun, 1981).

In the rainy season in the area being investigated, the surface air is highly humid (RH > 85%) due to the southwesterlies (the monsoon) that is prevalent during this period. Associated with this warm and moist flow are the convective-type clouds and water vapour which are the most important attenuators of the solar and atmospheric radiation. During the dry season, it is the hot and dry northeasterly trade wind, known locally as the harmattan that is prevailing. Its trajectory crosses over the Sahara desert and advects the dust (fine silt/clayey particles) that is

later deposited over the southern parts of Nigeria even extending up to the Gulf of Guinea (Adedokun *et al.*, 1989). Thus the dry season is marked by dry and wilting vegetation, scanty clouds (mostly high cirrus), and a high aerosol loading of the atmosphere.

The period when the NIMEX-1 field study was held, that is, 15th February to 10th March, 2004, was a transition from the dry to wet surface conditions in Ile-Ife. It is remarkable that the first rain of the year at our site in Ile-Ife, recorded on the 24th February, was some days well into the measurement phase which hitherto had been very dry at the surface (as is typical of the dry season in the area). This was followed by two consecutive days of heavy evening thunderstorms on the 25th and 26th of February. Beyond the 26th February 2004, grasses and shrubs began to sprout and the measurement area started turning to green. Thus the changing climatic conditions enabled the present investigation to compare and contrast the energy balances between the two climatic regimes that are experienced in the area.

3. Methodology

The main energy exchange processes that are taking place at the ground surface (assuming it is bare soil), can be written in the form of the so-called energy balance equation:

$$-Q_N = Q_H + Q_E + Q_G \quad (1)$$

where,

Q_N = net (all-wave) radiation

Q_H = sensible heat flux between the surface and the atmosphere.

Q_E = latent heat flux between the surface and the atmosphere.

Q_G = ground heat flux (i.e. the vertical heat flux between the surface and the soil)

Particularly at the daytime, the net radiant energy, Q_N gained by the surface is transported mainly by turbulent fluxes to the atmosphere (as sensible and latent heat fluxes) and is partly conducted into the soil. From Eq. (1), the knowledge of net radiation is crucial for partitioning of the available energy (i.e., $Q_N - Q_G$) and thus controls the energy exchange processes at the surface (see Monteith and Unsworth, 1990).

The magnitude of Q_N at the surface is determined as algebraic sum of the incoming and outgoing shortwave (0.29 μm – 3 μm), and longwave (3 μm – 100 μm) atmospheric radiation components. The measurement of net radiation at the surface can be accomplished by use of a net radiometer. Basically,

there are two main designs: one type is constructed with separate upward- and downward-looking sensors combined through a body of high thermal capacity and conductivity; and in the other, the sensor is exposed at both ends to the radiation. In nearly all the instrument designs commercially available, there are technical problems such as, the time constant, drift, linearity of output, directionality, spectral selectivity, temperature response, and zero offset that should be taken into consideration (Halldin and Lindroth, 1992; Halldin, 2004). There exist in the literature several meteorological empirical relationships that can be used to determine quantitatively the net radiation. However most are location specific and can depend on the atmospheric conditions such as transmissivity (see Holtslag and van Ulden, 1983; Stull, 1988; Jegede, 1997).

The surface turbulent heat fluxes, Q_H and Q_E , both of which appear in the energy balance Eq. (1), can be measured directly by the eddy covariance (EC) method (Fuehrer and Friehe, 2002; Brotzge and Crawford, 2003; Foken *et al.*, 2004; Moncrieff, 2004). This method makes use of fast response sensors (e.g., ultrasonic anemometers) in order to record the whole spectrum of turbulent fluctuations (Lee *et al.*, 2004.). It is typical to measure the fluctuations of the wind speed, temperature and humidity at frequencies of 10 Hz to 20 Hz.

Another but indirect technique that can be used to determine the sensible and latent heat fluxes at the surface is the Bowen ratio energy balance (BREB) method (Foken *et al.*, 1997; Stannard, 1997; Jegede *et al.*, 2001; Balogun *et al.*, 2002). This method is based on the surface energy balance (which sometimes is a tenuous assumption) together with the ratio of the two turbulent heat fluxes, Q_H and Q_E , (termed as the Bowen ratio, Bo). The non-closure of the energy balance equation (given in Eq. 1) at the surface can be due to a number of conditions: instrumental errors, advection and inhomogeneous surfaces amongst others (Culf *et al.*, 2004.). Assuming that there is a similarity between the eddy diffusivities for heat and moisture fluxes (see Bowen, 1926), then the Bowen ratio can be approximated as:

$$Bo = \frac{Q_H}{Q_E} \cong \gamma \cdot \frac{\Delta T}{\Delta e}, \quad (2)$$

where,

the psychrometer constant, $\gamma = 0.667 K hPa^{-1}$, for $p = 1000 hPa$ and $T = 20^\circ C$, ΔT is the temperature difference [K] between two heights z_1 and z_2 , and Δe is the vapour pressure difference hPa between the same heights.

Basically the BREB method breaks down when the

value of the estimated Bowen ratio falls within the range: $-1.25 < Bo < -0.75$, which is typical of the dusk and dawn conditions at the surface. According to Foken *et al.* (1997), to properly resolve the gradients, the ratio of the temperature measurement heights, z_2/z_1 should lie within the range, 4 to 8. For appraisal of validity and applicability of the BREB method, papers by Ohmura *et al.* (1982), Fritschen and Simpson (1989), Heilman *et al.* (1989) and Foken *et al.* (1997) are relevant.

A modification of the BREB method which avoids the forced assumption of energy closure at the surface is the so-called modified Bowen ratio (MBR) method introduced by Liu and Foken (2001). In this technique, by use of a sonic anemometer, an independent measurement of the buoyancy heat flux is obtained and is corrected for humidity using the formula proposed by Schotanus *et al.* (1983), and then the sensible heat flux is calculated. The value of sensible heat flux with the Bowen ratio is used to determine the latent heat flux at the surface.

4. Experimental set-up and data processing

The area investigated was used for experimental agricultural cropping and the terrain was level of approximately 100000 sq. metres (288 m a.m.s.l.). Beyond this surface was forest and gently undulating, representing the vegetative cover of the area. Essentially for the NIMEX-1 field study, the mean and turbulent parameters in the surface layer were measured simultaneously, hence the meteorological instrument comprised of both slow and fast response sensors. Three measurement complexes; M1, M2, and M3 (forming a network) were set up within the measurement domain. The locations of these measuring points are shown in the Fig.1. The masts, booms and clamps were fabricated locally by the staff of the mechanical workshop at the Department of Physics of Obafemi Awolowo University. A list of all the equipment is contained in Table 1.

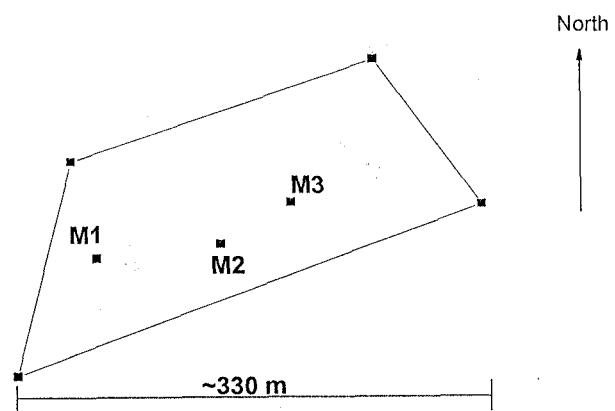

Fig. 1: The positioning of the three complexes: M1, M2 and M3, within the measurement domain

Table 1: List of instruments deployed during the NIMEX-1 field study

Parameter	Device and model	Manufacturer	Accuracy	Number
Wind speed	Cup anemometer A101ML/A100L2	Vector Instruments	distance const. 2.3 m	10
Wind direction	Wind vane W200P	Vector Instruments	distance const. 2.3 m	2
Air temperature (wet and dry bulb)	Frankenberger Psychrometer	Theodor Friedrichs	$\pm 0.05^\circ\text{C}$	5
Surface temperature	Infrared Pyrometer KT1582D	Heitronics	$\pm 0.5^\circ\text{C}$	1
Soil temperature	PT-100 Ω	Thermo. Werk	$\pm 1^\circ\text{C}$	6
Soil temperature	Thermistor, Thermocouple	Campbell Scientific	$\pm 1^\circ\text{C}$	3
Soil heat flux	Heat flux plate HP3/CN3	Middleton	$\sim 13.5 \mu\text{V}/\text{Wm}^{-2}$	3
Soil heat flux	Heat flux plate HFP01	Hukseflux	$50 \mu\text{V}/\text{Wm}^{-2}$	1
Soil moisture	Water content reflectometer CS615/CS616	Campbell Scientific	$\pm 3\%$ of water content	2
Global radiation	Pyranometer SP-LITE	Kipp & Zonen	$80 \mu\text{V}/\text{Wm}^{-2}$	1
Net radiation	Net radiometer (REBS) Q7, NR-LITE	Campbell/ Kipp & Zonen	$+9.6 (-11.9) \mu\text{V}/\text{Wm}^{-2} / 13.9 \mu\text{V}/\text{Wm}^{-2}$	2
Rainfall amount	Raingauge ARG100	Campbell Scientific	0.203mm/TIP	1
Air pressure	Capacitive barometer	Ammonit	1 hPa	2
Turbulent Flux	Ultrasonic anemometer USA-1	METEK	10Hz	1
Data acquisition	Datalogger CR10X	Campbell Scientific	Not applicable	3

A 15-m mast (position M2 in Fig. 1) was configured to measure the profiles of the mean wind speed at the following heights: 0.7 m, 1.2 m, 2.2 m, 3.3 m, 5.2 m, 7.2 m, 10.2 m and 14.8 m (the wind direction is inclusive only at the 14.8 m height) and air temperature (wet and dry bulb) at 0.9 m, 4.9 m and 10.0 m (see Fig. 2a). In addition, the same mast supported radiation sensors for the global and net radiation (both at 1.5 m). In the earth close to the mast position were buried soil thermometers (5 cm, 10 cm, and 30 cm) and heat flux plates (2 cm [5 cm], 10 cm, 30 cm). Other measurements made included surface temperature, air pressure, rainfall amount and soil moisture. The slow measurements were controlled by use of two Campbell CR10X dataloggers which sampled the data every 1 sec. and then subsequently stored them as 1 min. averaged values.

The EC data acquisition system used comprised of a 3-D ultrasonic anemometer (model USA-1, manufactured by METEK, Germany) together with a krypton hygrometer (model KH20, manufactured by Campbell Scientific, USA) as shown in Fig. 2b. The two devices (that is, the sonic anemometer and krypton hygrometer) were sampled at frequencies of 16 Hz and 8 Hz respectively. The sonic anemometer measurements provided direct digital data output of the fluctuating wind components: u ,

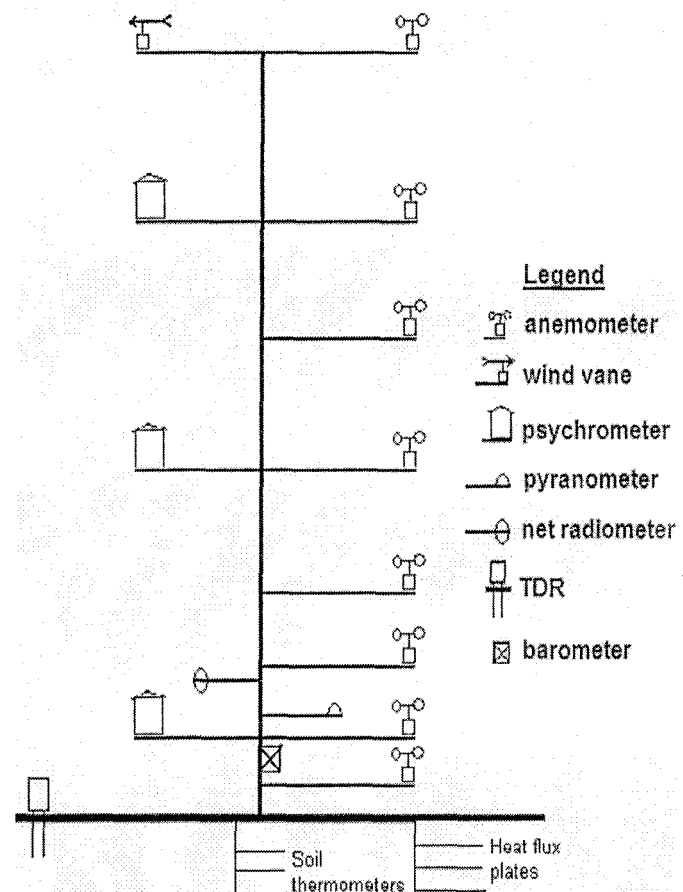

Fig. 2a: Measurement complex M2 (see the text for details)

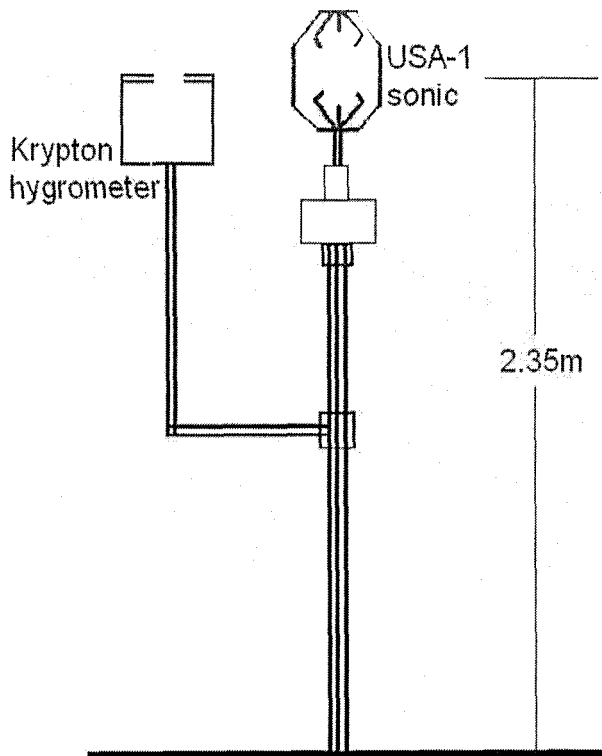

Fig. 2b: Measurement complex M3 (see the text for details)

v , w , and the sonic temperature, T_s , while the absolute humidity fluctuations were measured as analogue signal from the krypton hygrometer. These data were then processed together for the turbulence statistics. Because of the time delay in the sampling speeds of the two sensors, a cross correlation analysis was performed for each averaging interval to determine a maximum value of the covariance. The software developed by the Department of Micrometeorology of the University of Bayreuth, TK2 (Mauder and Foken, 2004) was used to handle the data quality assessment and control and subsequently to calculate the turbulent fluxes.

5. Results

(a) The surface conditions during the NIMEX-1 study

The NIMEX-1 field project ran between February 15 and March 10, 2004 (that is, Day of the Year (DOY) 46 to 70). During the experiments routine observations of the basic meteorological conditions at the site were made as well. The appendix is showing the daily weather occurrences (including air temperature, relative humidity, mean wind speed and direction, and solar radiation) within a special observation period, chosen as the DOY 55 to 70. From the records available, the first rain of the year occurred on DOY 55 in the evening (about 6pm local time) and again on the DOY 56 and 57, heavy rain was also recorded at about 7.30pm. These precipitation events transformed the dry surface conditions to wet and within days, brought about sprouting of shrubs and grasses on the measurement surface. Between the DOY 65 and 68 the visibility in the area was poor due to a sustained surge of turbid air (coming from the northeasterly wind direction, a manifestation which is known locally as the "harmattan").

In the Figs. 3(a) and (b) are shown the wind speed, air temperature and relative humidity (at 2m height) for the period: DOY 53 to 59. Generally, the surface winds observed were weak ($\bar{u} < 1.5 \text{ ms}^{-1}$), and it was only during stormy weather that the gusts reached up to 6 ms^{-1} . The wind-direction at the surface for the period was predominantly northeasterly, which is in agreement with the climatological trend of the area for this period. The air temperature ranged between a minimum of $20.3 \text{ }^\circ\text{C}$ (this was recorded at 21.32 hr on DOY 57, shortly after a rainstorm) and a maximum of $35.8 \text{ }^\circ\text{C}$ at 16.00hr on DOY 54. The relative humidity for both the early morning and late night hours was nearly 100%, but during the hot afternoons these values

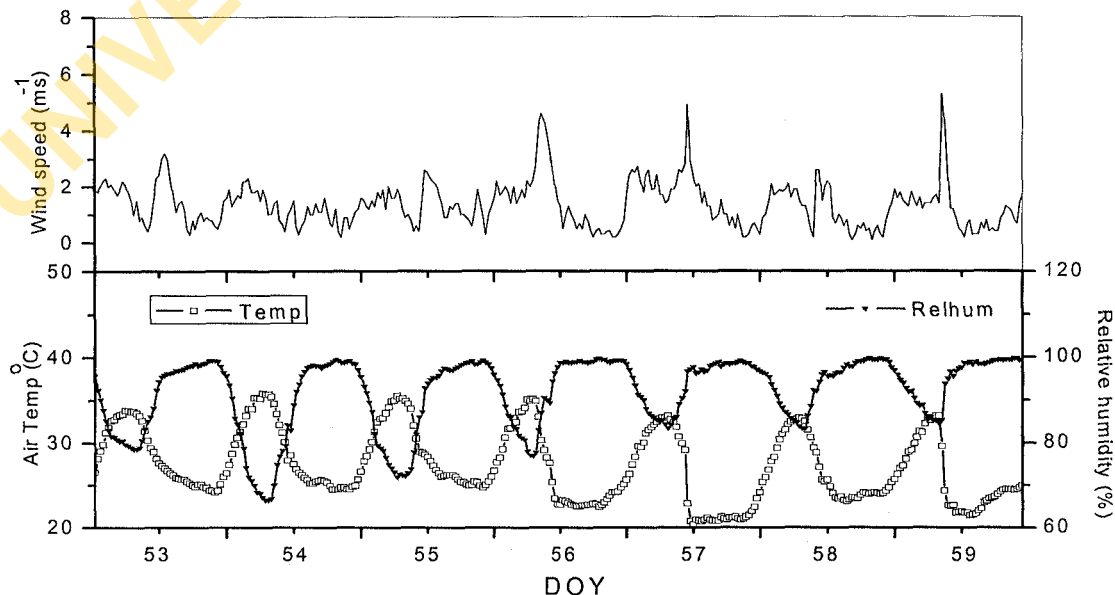

Fig. 3: Diurnal variations of wind speed, air temperature, relative humidity at 2m during the DOY 53 - 59 of NIMEX-1.

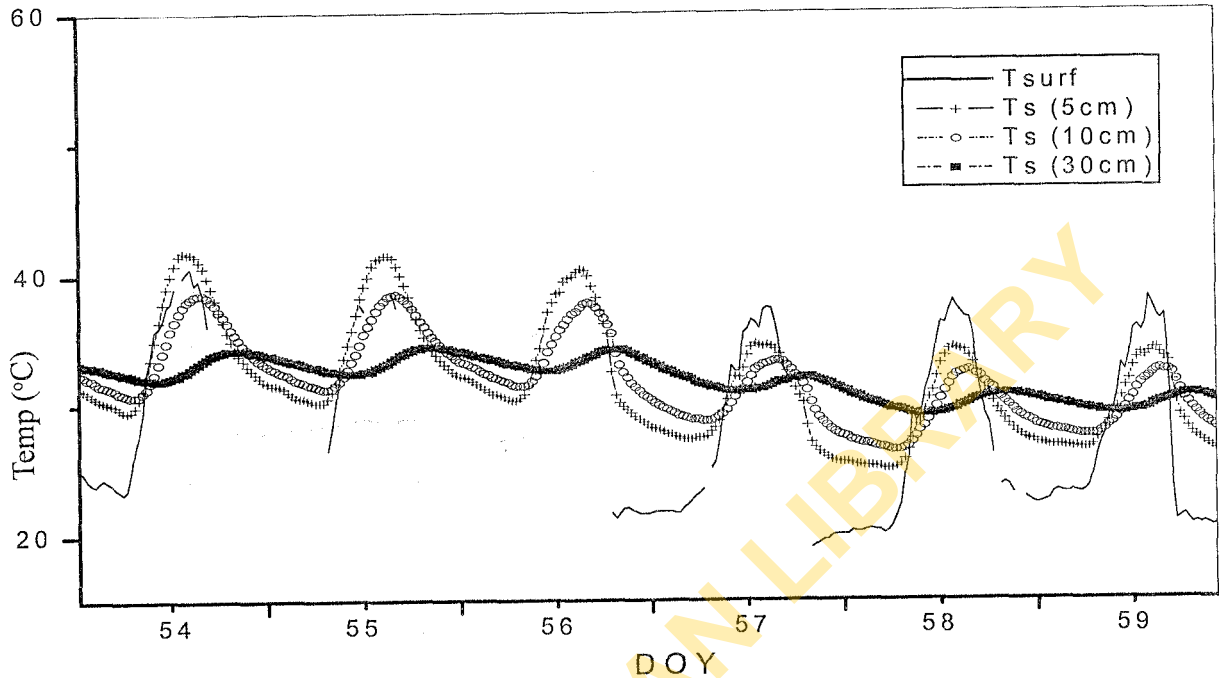

Fig. 4: Diurnal variations of surface temperature and soil temperatures (at 5 cm, 10 cm and 30 cm) during the DOY 53 - 59 of NIMEX-1.

can drop to about 65 %. On the days with heavy rainstorm occurrence in the previous evening (e.g. DOY 56), the afternoon humidity value was well above 85%.

The surface (skin) and soil temperature (depths at 5 cm, 10 cm, and 30 cm) trends for the DOY 54 to 60 are depicted in the Figs. 4. The time series indicated that as soon as the heavy rains on the nights of DOY 56 and 57 occurred, their daily mean values fell considerably. This is most probably because the wetting of the patched ground surface had significantly increased the latent heat flux (as from DOY 57 onwards) and consequently lowering the amount of conductive heating into the soil sub-medium. This portrayed a gradual transition from the hot and dry conditions at the surface, which is typical of the dry season, to the warm and moist ground during the wet season. When turbid conditions occurred as from DOY 65 onwards, lowering of net radiation at surface further reduced the mean soil temperature recorded at these depths.

(b) The surface energy fluxes

All the terms of the surface energy fluxes: net radiation, sensible and latent heat fluxes, and the soil heat flux were measured consecutively for the period of observation during NIMEX-1. Different numbers of measurement systems were used and these are: eddy covariance (EC) method, Bowen ratio energy balance (BREB) method, and the modified-Bowen ratio (MBR) method. All these various measurement platforms were compared and they showed good consistency.

Case studies of the surface energy fluxes when the BREB, EC, and MBR data were available are presented. Fig.5 depicts the comparison of the sensible and latent heat fluxes as estimated by BREB and EC. In Fig. 5(a), which is for DOY 57 only the sensible heat flux has been compared, but both fluxes are compared for the DOY 61 (see Fig. 5(b)). Clearly in both cases, there is overestimation of the sensible and latent heat fluxes by BREB. On DOY 57 (see Fig.5a) BREB overestimated the sensible heat flux by about 30%. In the same figure, the sharp drop in the sensible heat flux at about the local noon is due to cloud manifestations.

Figs. 6 (a) and (b) compare the latent heat fluxes estimated by BREB and MBR with EC. Both the BREB and MBR estimates of the latent heat flux on DOY 61 were compared to the EC measurements. The figure indicated that there was a considerable scatter on the line of best fit (1:1) which shows the dependence of the estimates on the value of the Bowen ratio (that is, the estimated temperature and humidity gradients). Further comparison of the two methods (BREB and MBR) is presented in Fig. 6b. The distribution of the points shows good agreement between MBR and BREB though there is some scatter.

In the Figs. 7(a) and (b) are shown the surface energy balance for the DOY 57 and 66 as obtained from the BREB and the EC systems respectively. Remarkably, the conditions on these two days are quite different. In the evening (about 7.30 pm) of DOY 56, there was a heavy rainstorm which caused the surface to

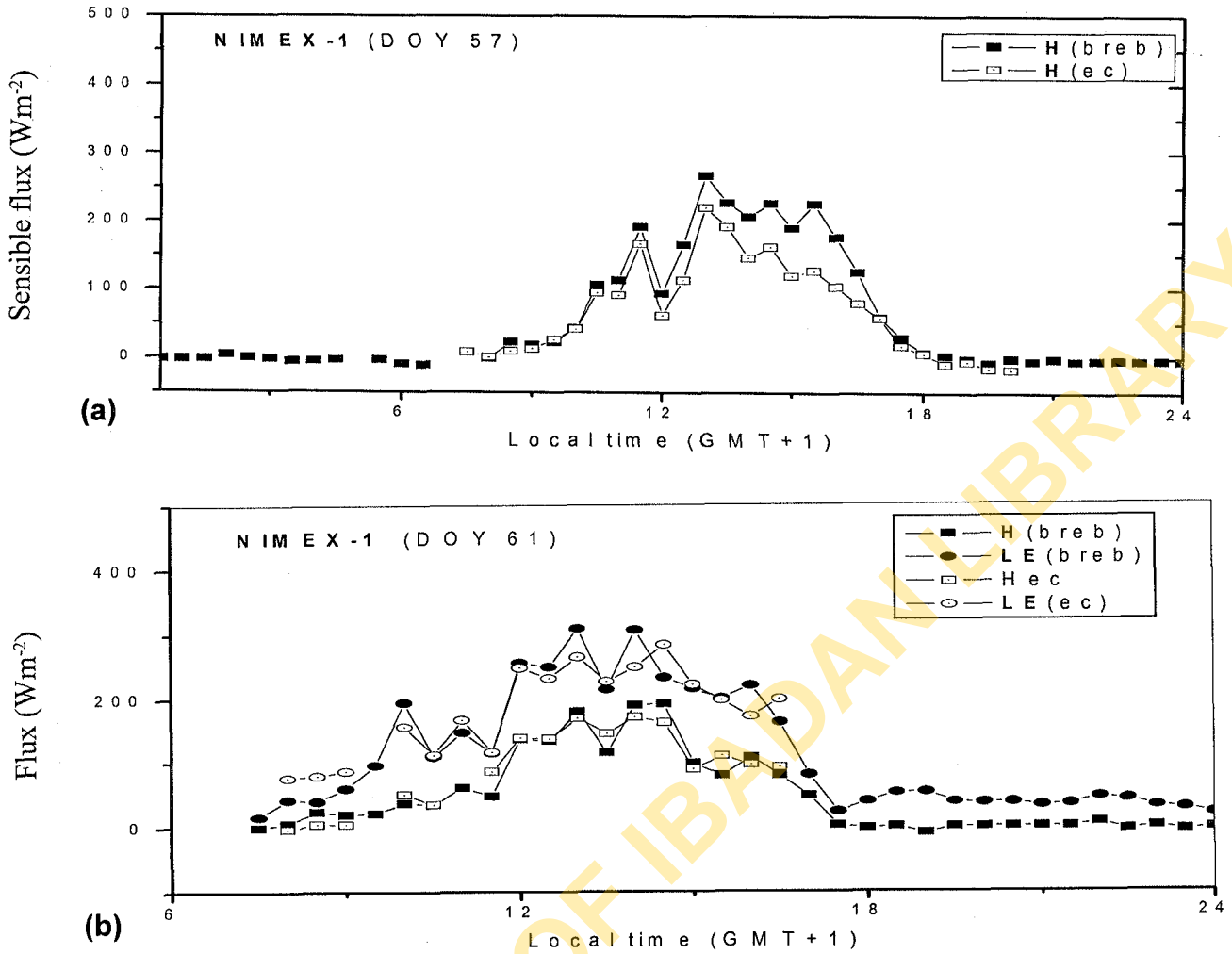

Fig. 5: Comparison of the sensible and latent heat fluxes estimated by BREB method with EC method

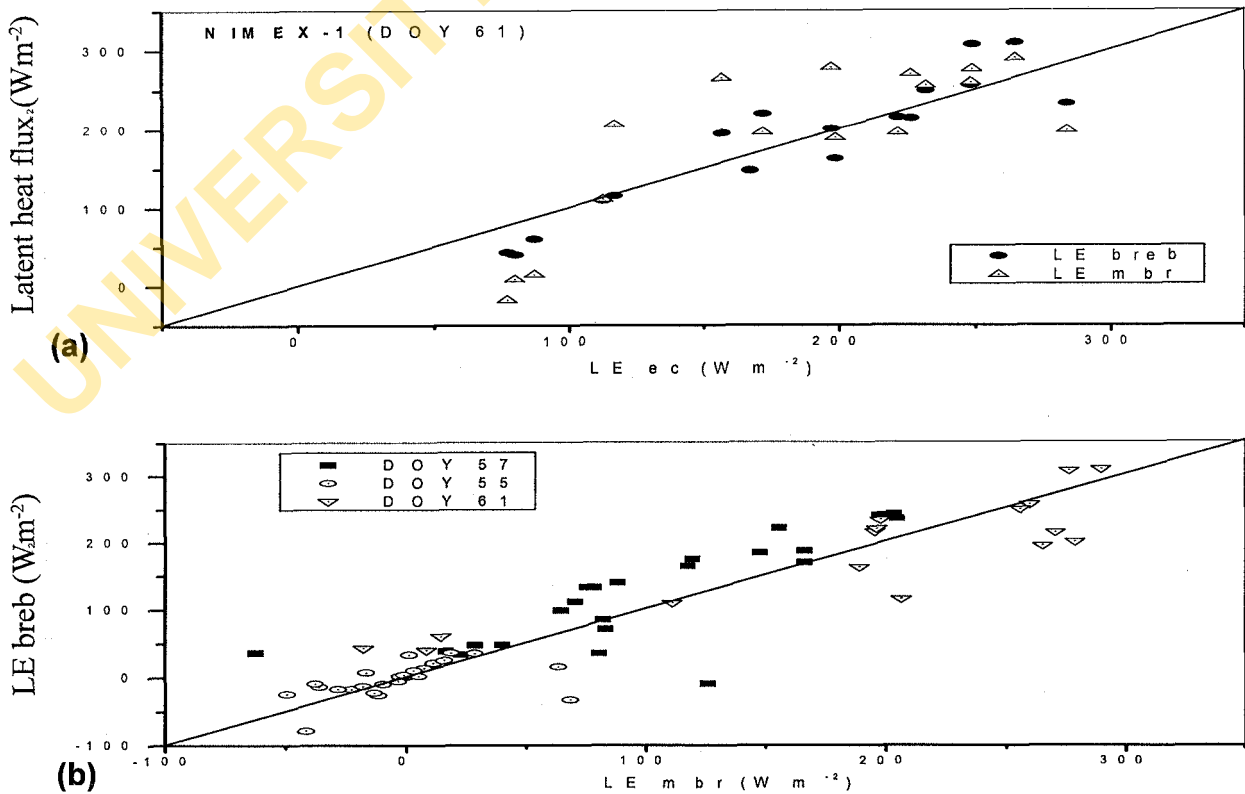

Fig. 6: Comparison of latent heat fluxes estimated by BREB and MBR methods with EC method

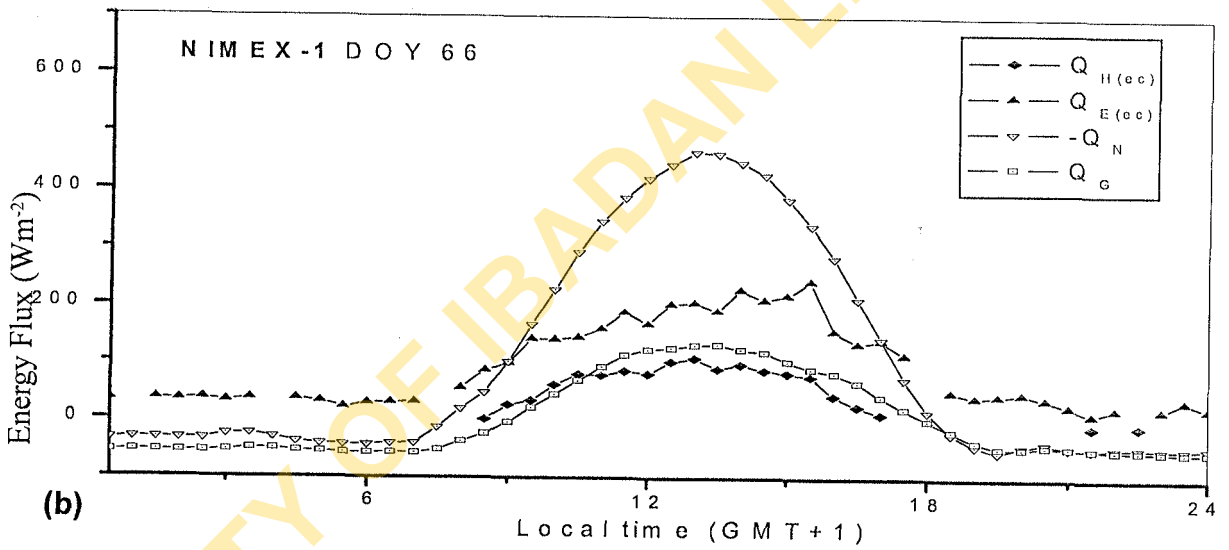
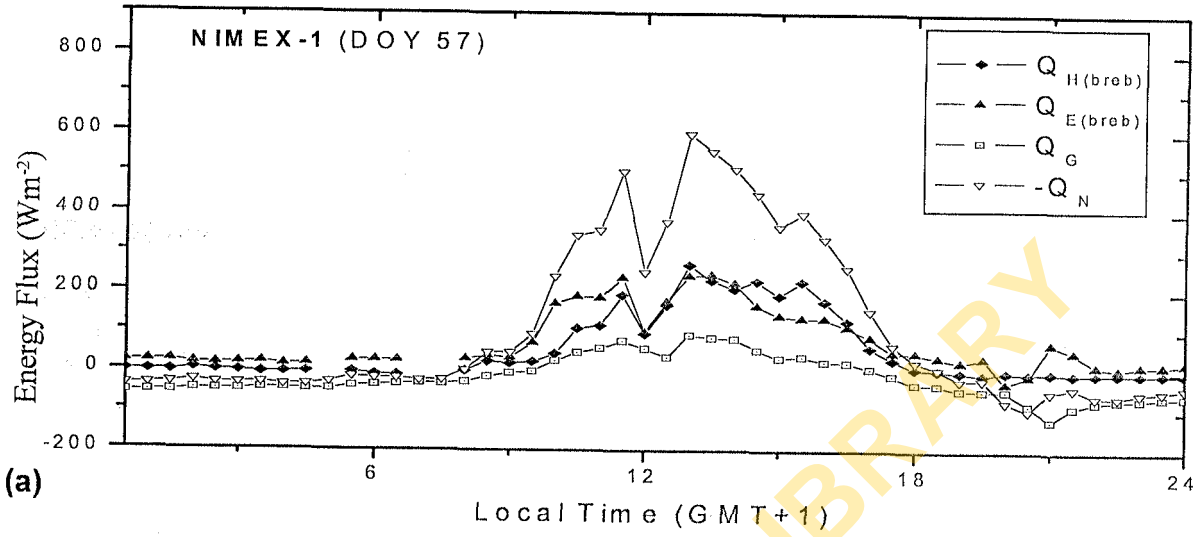

Fig. 7: The surface energy balance on DOY 57 and 66 as obtained from (a) BREB and (b) EC methods

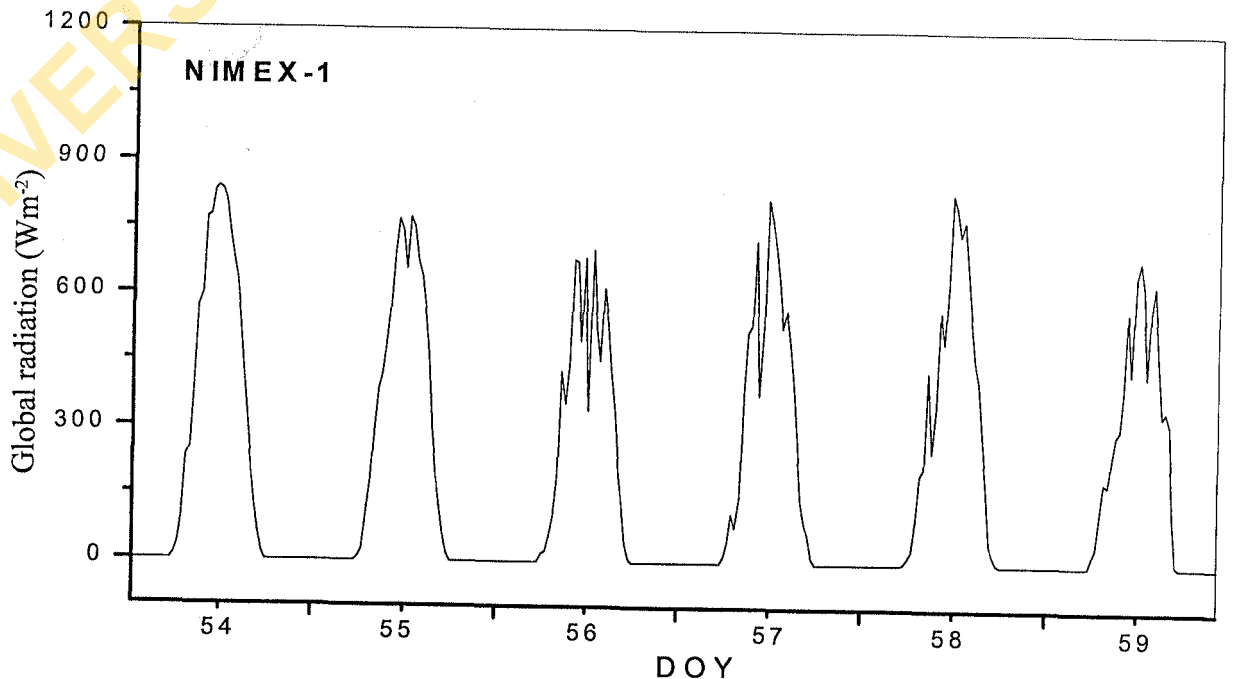

Fig. 8: The diurnal trend of global radiation for DOY 54 to 59 at the NIMEX-1 site

be wetted most of the DOY 57. The relative humidity was 94.1 % and the near surface soil wetness as measured by a TDR instrument was about 14.1% by volume. For this day, the net radiation recorded was as much as about 650 Wm^{-2} . Most of the available energy was used as latent heating with the values reaching as high as 300 Wm^{-2} . The surface sensible heating rose to as much as 250 Wm^{-2} . But the ground heat was considerably low, about 80 Wm^{-2} . This of course was attributed to the high evaporative flux taking place at the surface.

In contrast to the above scenario, the condition on DOY 66 was relatively dry (the relative humidity was 66%) and there was a surge of dusty air enveloping the whole area (the visibility was generally poor). Due to the hazy sky conditions that prevailed, the daytime net radiation fell to about 450 Wm^{-2} (see Fig. 7b). The EC measurements estimated the latent heat flux values (less than 250 Wm^{-2}) to be higher relatively than the sensible heat thus indicating most of the available energy went to evaporate water from the surface.

(c) The surface radiation balance

The global radiation trend for the DOY 54 to 59 is depicted in the Fig. 8. In that figure, except for those days with considerable amounts of cloudiness, the 30-min. average values of global radiation peaked often to about 850 Wm^{-2} . But during the period DOY 65 to 68, when there was a surge of dust storm over the area, this greatly reduced the levels of the maximum global radiation to about 600 Wm^{-2} . In Figs. 9a and b, the thirty minutes average values of global radiation measured using the Campbell Scientific SP-LITE pyranometer (sensitivity: $80 \mu\text{V}/\text{Wm}^{-2}$) and similar values of the net radiation obtained with the NR-LITE net radiometer (sensitivity: $13.9 \mu\text{V}/\text{Wm}^{-2}$) are compared with the equivalent measurements made with Kipp and Zonen net radiometer model CNR-1, which here is taken as the standard instrument (it has a better accuracy and time constant). It should be remarked that both the SP-LITE and NR-LITE were placed at the position M2 (see Fig. 1), while the CNR-1 was at the position M1, almost a distance of 200 m apart.

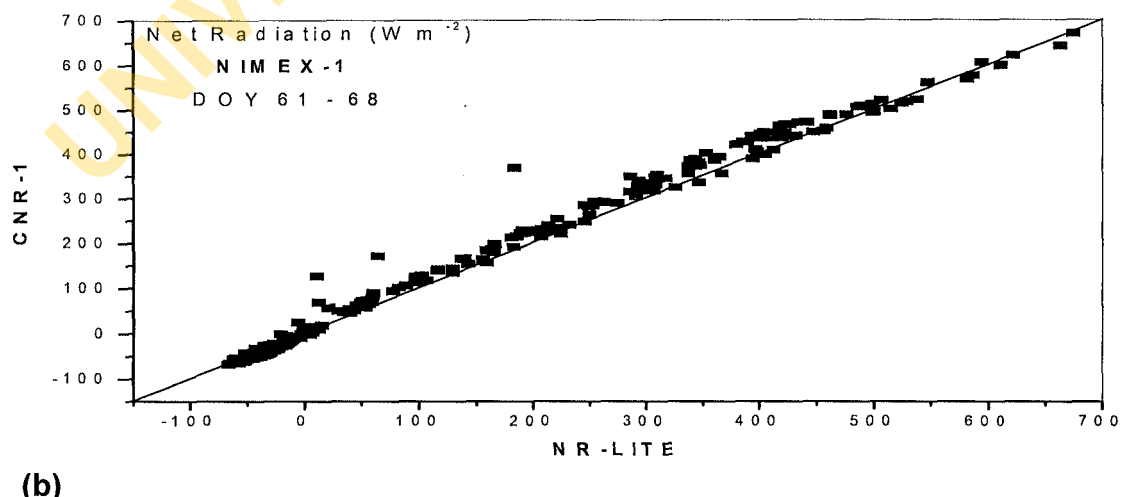
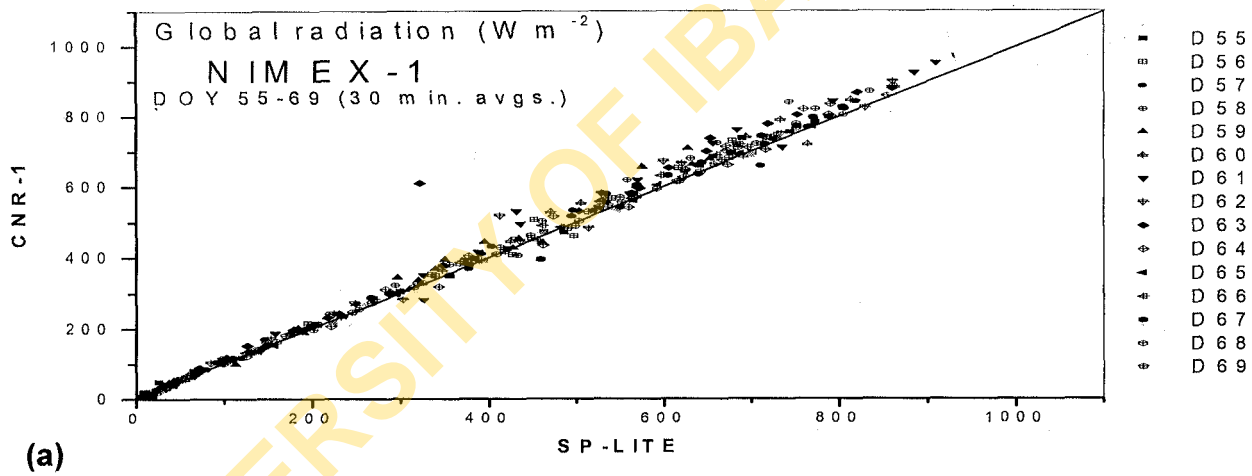

Fig. 9: Comparisons of (a) global and (b) net radiation as measured by SP-LITE and NR-LITE radiometers respectively with a reference net radiometer, CNR-1.

From the Fig. 9a, which is for the global radiation, it can be observed that both instruments compare very well but there was an underestimation by the SP-LITE pyranometer which was less than 5%. On the part of the NR-LITE net radiometer, shown by the Fig. 9b, it showed a similar tendency of underestimating the net radiation, but in this case by as much as 10%. However, it should be understood that the considerable distance of separation of the radiation stands (that is, SP-LITE and NR-LITE as against CNR-1), could matter much in the recorded values especially when there were drifting low level clouds. Moreover, it is recognised that the instruments have longer time constants and also

relatively less sensitive than the standard (CNR-1). As such there are bound to be considerable disparities of their values particularly during cloudy conditions. This can be seen in Fig. 9b where the underestimation by the NR-LITE particularly between 100 and 350 Wm^{-2} , is large (mostly when it is cloudy during the daytime).

The surface radiation balance for the DOY 59 is shown in the Fig. 10. The data presented are 1 min. average values. The prominence of clouds in attenuating the incoming solar radiation is quite manifest. The drifting clouds continually bring about the fluctuations as was observed in all the radiation components measurements.

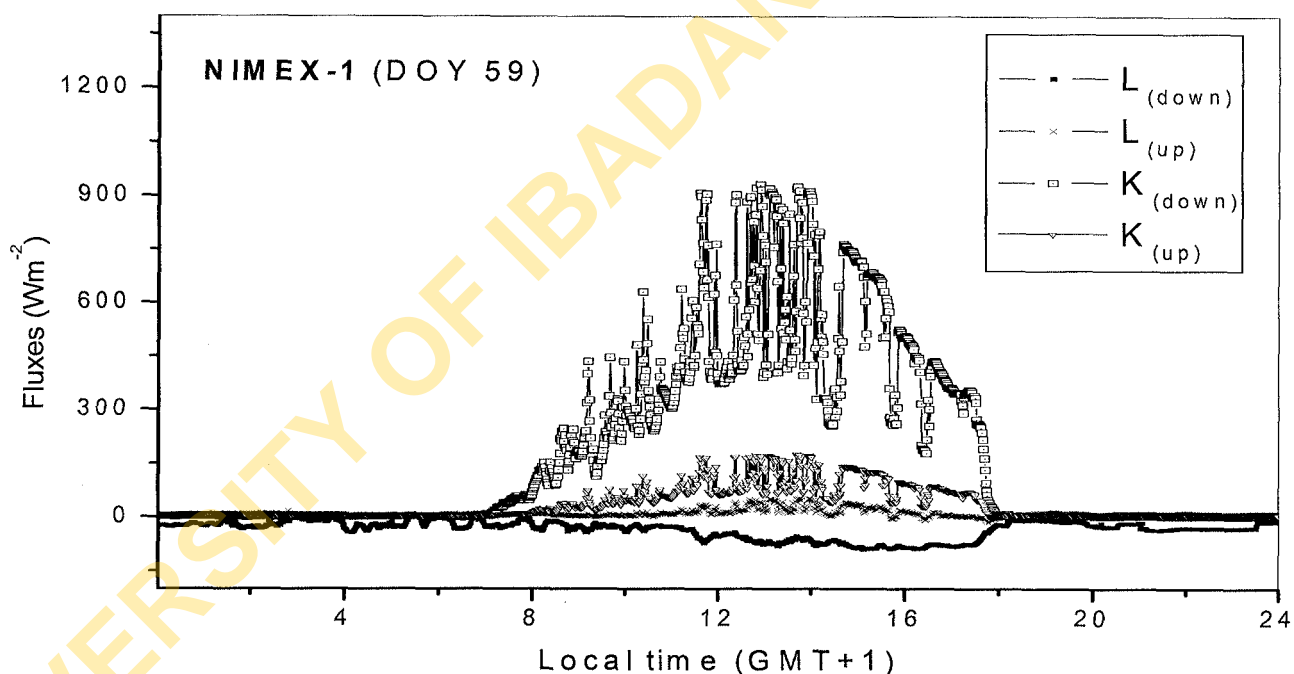

Fig. 10: The radiation components measured, both shortwave and longwave, at the NIMEX-1 site on DOY 59.

6. Conclusion

Accurate measurements of the surface sensible and latent heat fluxes are required for research and applications in weather and climate modelling, agriculture and hydrology. Such data for the humid zone of the West Africa is scarce. Thus the main goal for organising the NIMEX-1 field project was to quantitatively determine the magnitude of the terms in the surface energy balance equation for the conditions that are typical of a tropical (wet and dry) area, for the southwest part of Nigeria. In almost all of the less developed countries (LDC), there is insufficiency of facility and man-power to carry out dedicated measurements of the micrometeorological parameters.

The NIMEX-1 period of study, which was from February 15 to March 10, 2004 presented diverse surface conditions, from the completely dry surface (at the beginning) to the wet surface (about DOY 56-58) and later manifested a turbid condition. These contrasting scenarios produced different surface budgets which were critically examined in this study.

The extensive data base acquired from the NIMEX-1 project also allowed an opportunity to compare the different measurement platforms. Similarly the radiation budget was examined.

It is believed that the present data will be used to consolidate with the extension of the micro-

meteorological measurements to other nearby locations, at Akure and Ibadan, where the microscale systems can be studied in relation to the mesoscale features.

REFERENCES

- Adedokun, J.A., 1978. West African precipitation and dominant atmospheric mechanisms. *Arch. Met. Geoph. Biokl., Ser. A* 27, 287-310.
- Adedokun, J.A., Emofurieta, W.O. and Adedeji, O.A., 1989. Physical, mineralogical and chemical properties of harmattan dust at Ile-Ife, Nigeria. *Theoretical and Applied Climatology* 40, 161-169.
- Adejokun, J.A., 1966. The Three Dimensional Structure of the Intertropical Discontinuity over Nigeria, Meteorological Services, Lagos, Nigeria. Nigerian Meteorological Service Technical Note No. 39, 9pp.
- Balogun, A.A., Jegede, O.O., Foken, Th. and Olaleye, J.O., 2002. Estimation of sensible and latent heat fluxes over bare soil using Bowen ratio energy balance method at a humid tropical site. *Journal of the African Meteorological Society* 5(1), 63-71.
- Balogun, E.E., 1981. Seasonal and spatial variations in thunderstorm activity over Nigeria. *Weather* 36, 192-197.
- Brotzge, J.A. and Crawford, K.C., 2003. Estimation of the surface energy budget: A comparison of eddy correlation and Bowen ratio measurement systems. *Journal of Hydrometeorology* 4, 160-177.
- Culf, A.D., Foken, T. and Gash, J.H.C., 2004. The energy balance closure problem. In: *Vegetation, Water, Humans and the Climate: A New Perspective on an Interactive System (IGBP series)*. P. Kabat *et al.* (eds.), Springer, Berlin. Chapter B.2, pp. 159-166.
- Foken, T., 2003. *Angewandte Meteorologie: Mikrometeorologische Methoden*. Springer Verlag, Heidelberg, 289pp.
- Foken, T., Göckede, M., Mauder, M., Mahrt, L., Amiro, B.D. and Munger, J.W., 2004. Post-field data quality control. In: *Handbook of Micrometeorology: A Guide for Surface Flux Measurements*. X. Lee (Editor), Kluwer, Dordrecht, pp. 81-108.
- Foken, Th., Richter, S.H. and Muller, H., 1997. Zur Genauigkeit der Bowen-ratio methode (In English: The accuracy of the Bowen ratio method), *Wetter und Leben* 49, 57-77.
- Foken, T. and Wichura, B., 1996. Tools for quality assessment of surface-based flux measurements. *Agricultural and Forest Meteorology* 78, 83-105.
- Fritschen, L.J. and Simpson, J.R., 1989. Surface energy and radiation balance systems: general description and improvements. *J. Appl. Meteor.* 28(7), 680-689.
- Fuehrer, P.L. and Friehe, C.A., 2002. Flux correction revisited. *Boundary-Layer Meteorology* 102, 415-457.
- Haldin, S., 2004. Radiation measurements in integrated terrestrial experiments. In: *Vegetation, Water, Humans and the Climate: A New Perspective on an Interactive System (IGBP series)*. P. Kabat *et al.* (eds.), Springer, Berlin. Chapter B.3, pp. 167-171.
- Haldin, S. and Lindroth, A., 1992. Errors in net radiometry, comparison and evaluation of six radiometer designs. *Journal of Atmospheric and Oceanic Technology* 9, 762-783.
- Hastenrath, S., 1991. *Climate Dynamics of the Tropics*. Kluwer Academic Publishers, Dordrecht. 488pp.
- Heilman, J.L., Brittin, C.L. and Neale, C.M.U., 1989. Fetch requirements for Bowen ratio measurements of sensible and latent fluxes. *Agric. For. Meteorology* 44, 261-263.
- Holtstag, A.A.M. and van Ulden, A.P., 1983. A simple scheme for daytime estimates of the surface fluxes from routine weather data. *Journal of Climate and Applied Meteorology* 22, 517-529.
- Jegade, O.O., 1997. Estimating net radiation from air temperature for diffusion modelling applications in a tropical area. *Boundary-Layer Meteorology* 85, 161-173.
- Jegade, O.O., 2002. Observations of daytime surface energy balance in cloudy tropical conditions at Ile-Ife, Nigeria. *Mausam* 53(3), 359-366.
- Jegade, O.O., Foken, Th., Balogun, A.A. and Abimbola, O.J., 2001. Bowen ratio determination of sensible and latent heat fluxes in a humid tropical environment at Ile-Ife, Nigeria, *Mausam* 52(4), 669-678.
- Jegade, O.O., Okogbue, E.C. and Balogun, E.E. (eds.), 2004. *Proceedings of the Workshop on the Nigerian Micrometeorological Experiment (NIMEX-1)*. July 15, 2004. Ile-Ife, Nigeria. Comfort Press and Publishing Co., Lagos, Nigeria. 66pp.
- Koorevar, P., Menelik G. and Dirksen, C., 1983. *Elements of Soil Physics*, Elsevier, Amsterdam. 228pp.
- Lee, X. and Massman, W.J. (eds.), 2004. *Handbook of Micrometeorology: A Guide for Surface Flux Measurement and Analysis*. Kluwer, Dordrecht. 250 pp.
- Liu, H. and Foken, T., 2001. A modified Bowen ratio method to determine sensible and latent heat fluxes. *Meteorologische Zeitschrift* 10, 77-80.
- Mauder, M. and Foken, T., 2004. *Documentation and Instruction Manual of the Eddy Covariance Software Package Turbulenzknecht 2*. Universität Bayreuth, Abt. Mikrometeorologie, Arbeitsergebnisse (ISSN 1614-8916) Nr. 26, *in print*.
- Moncrieff, H., 2004. Surface turbulent fluxes. In: *Vegetation, Water, Humans and the Climate: A New Perspective on an Interactive System (IGBP series)*. P. Kabat *et al.* (eds.). Springer, Berlin. pp. 173-182.
- Monteith, J.L. and Unsworth, M.H., 1990. *Principles of Environmental Physics* (second ed.). Edward Arnold, 291 pp.
- Ohmura, A., 1982. Objective criteria for rejecting data for Bowen ratio flux calculations. *Journal of Climate and Applied Meteorology* 21, 595-598.
- Schotanus, P., Nieuwstadt, F.T.M. and De Bruin, H.A.R., 1983. Temperature measurement with a sonic anemometer and its application to heat and moisture fluctuations. *Boundary-Layer Meteorology* 26, 88-93.
- Stannard, D.I., 1997. A theoretically based determination of Bowen-ratio fetch requirements. *Boundary-Layer Meteorology* 83, 375-406.
- Stull, R.B., 1988. *An Introduction to Boundary Layer Meteorology*. Kluwer Acad. Publ., Dordrecht. 666pp.

Appendix

The synoptic weather observations made during the SOP of the NIMEX-1

Day of Year (DOY)	Mean Wind speed (ms ⁻¹)	Wind direct. (degs.)	Daily Average Temp (°C)	Rel. hum. (%)	Daily Avg. Global radiation (Wm ⁻²)	Synoptic conditions
55	1.2	210.4	29.5	89.3	206.4	A slight drizzle occurred at about 6p.m
56	1.5	198.5	28.3	92.7	176.8	Heavy rainstorm but short-lived (30mins) started at about 7.30pm
57	1.4	138.7	26.6	94.1	187.2	Heavy and violent rainstorm at about 8.pm (short-lived).
58	1.1	108.5	27.3	94.1	189.7	No rain
59	1.0	80.4	26.2	95.1	166.8	No rain
60	1.2	118.6	26.6	95.0	196.8	No rain
61	1.4	118.7	27.5	93.5	184.7	No rain
62	1.6	110.8	26.6	94.6	150.9	Slight drizzle at about 7.30pm.
63	1.1	40.6	26.6	90.5	173.9	No rain
64	1.4	25.0	27.9	78.7	235.6	No rain
65	1.9	352.1	25.2	52.5	166.7	Low-level fog in the early morning. Turbid conditions.
66	1.9	13.6	25.0	58.1	197.4	No rain. Low-level fog in the early morning hours. Turbid conditions.
67	1.5	13.0	26.3	61.2	221.4	No rain. Poor visibility persisted.
68	0.9	23.4	25.1	75.1	204.2	No rain. Poor visibility continued all day.
69	0.7	54.2	26.2	81.5	175.7	No rain
70	1.1	47.8	26.2	85.3	195.9	No rain